

**Cryogenic Service**  
Technical **Catalogue**

A full-page photograph of a person in winter gear climbing a steep, snow-covered mountain peak. The climber is positioned on the left side of the frame, facing right. The background is a vast, bright, and slightly hazy sky. The snow is thick and textured, with some rocky outcrops visible. The overall tone is bright and clean.

The best human team and a fully in-house  
integrated process enable us to offer  
top design and manufacturing  
of cryogenic valves.

# Index

	AMPO: Commitment made of Steel	04 - 05
1	Company Profile	06 - 13
2	General Overview of Cryogenic Service Valve	14 - 19
3	Why choose AMPO Valves When You Need Cryogenic Valves?	20 - 21
3.1	Providing Safe Valves in the New LNG Market	22 - 23
3.2	AMPO Engineering	24 - 25
3.3	Best Valve Quality	26 - 29
3.4	Best Valve Performance	30 - 47
4	Product Range	46 - 47
4.1	Ball Valves	48 - 55
4.2	Gate Valves	56 - 59
4.3	Globe Valves	60 - 63
4.4	Check Valves	64 - 67
5	F.E.S. (Field Engineering Service)	68 - 71
6	Worldwide Sales Network	72 - 75





## “Commitment made of Steel”

AMPO has been involved in many large international projects, supplying not only the product but expertise in project management, finance of high-value projects and logistical expertise to ensure trouble-free and on-time delivery of quality products. AMPO has been entrusted with the largest international projects by the world's leading engineering construction companies.

In short, Quality, Service, Cost, Innovation, Work Safety and Health and Shared Experience are the keys to our business.

The principal values which drive our company are based on:

Always achieving the highest professional competence.

Respecting confidentiality of information and intellectual property of our customers.

Maximum care of our customers, suppliers and the environment.

Promoting and managing change, taking initiatives and making commitments.

Working as a team, generating confidence and respect.



AMPO S. Coop., located in Idiazabal (Gipuzkoa), Spain, and founded in 1964, has extensive experience in the sector.

A close-up photograph of a person's face, focusing on the eye and forehead. The image is partially obscured by a large red rectangular overlay at the bottom. The person has light-colored hair and a focused expression.

## 1. Company Profile

“We handle our valves with the greatest care and attention at each stage of the manufacturing process. This is the key point for achieving best quality and optimum performance valves”

### 1 Company Profile

- 2 General Overview of Cryogenic Service Valve
- 3 Why Choose AMPO Valves
- 4 Product Range
- 5 FES (Field Engineering Service)
- 6 Sales Network





## Safety & Environment

At AMPO we are committed to improving and protecting the safety and health of our workforce; preventing contamination and complying with Environmental Legislation. We must therefore manage the natural resources efficiently and minimize the environmental impact caused by our business activity.

## Quality

**“Our commitment is to offer customers products and services under the most stringent quality processes in the market”**

Our operating and production processes are implemented and controlled by a quality assurance system, certified since 1991 under the ISO 9001 Standard, API Spec Q1 & 6D and SIL 3, accredited by the most important external organisations in the market, such as Lloyd’s Register, Nippon Kaiji Kyokai, Det Norske Veritas, TUV, Bureau Veritas and Germanischer Lloyd. We are continually undergoing revisions and audits, both internal and external, ensuring that AMPO meets customer requirements and fulfils international standards.

All production areas undergo intermediate and final inspections. These are documented with the corresponding certification and reports, directly coordinated by an efficient, highly-qualified team and always in accordance with internal and external Quality Assurance standards and procedures. Every step, from purchase order receipt through procurement, NDE, machining, assembling, testing, painting and packaging is in accordance with regulations stipulated in QA Manuals.

Internal Quality Control Personnel are highly-qualified to carry out Non-Destructive Examinations, such as X-ray, Dye Penetrant, Magnetic Particles and PAMI (positive alloy material identification).







We are equipped with the most modern installations and a highly-qualified human team, enabling us to offer the widest possible range of valves combining high standards in technology, quality and productivity, as well as tradition, experience and dependability, with an unrivalled reputation for quality and service.

## **Research & Development R+D+I**

**“AMPO R+D+I team have the skill, experience and most modern computer tools and equipment to assist our customers to whatever extent is needed”**

Our R+D+I department is continuously striving in these three vital areas in order to offer the best to our customers:

1. Technological Resources
2. Prototype Production
3. Customer Advice





## Human Team - Experience

AMPO's workforce comprises highly-trained, experienced and motivated specialists who understand the customer process, enabling us to offer a flexible product suited to customer needs with best quality and optimum performance in the most severe services.

Our extensive expertise in valve design, together with integrated CAD/CAM (Solid Works) systems fully exploit the opportunities for innovative and competitive engineering solutions whilst ensuring compliance with all relevant standards. AMPO is committed to developing and marketing new products based on customer needs.

OUR VALVE DIVISION has been particularly outstanding in developing new designs of larger valves for high pressure and temperature service, Cryogenic valves, Corrosion resistant valves, Aluminium refining valves and specially-engineered products for specific services, i.e. specialising in high specification project work.

- Latest CAD/CAM-3D design system.
- Seismic Calculations, Flow Simulations, Mechanical Analyses and Thermal Simulations by FEA (Finite Element Analysis), for optimizing our valve design performance.
- New materials and technology research.



**“Our aim is engineering efficiency:  
Our engineers are ready to help customers  
meet the most demanding design challenges  
and applications”**

### **Process analysis, Design and Improvement**

Work groups are formed in close cooperation with the customer for the purpose of troubleshooting processes using the tools and means available at AMPO. In addition to in-house resources, close ties with specialist research centres ensure that such analyses are always to the customer's satisfaction.

The combination of the know-how of plant personnel and of AMPO Engineering leads to truly satisfactory results in process innovative design, development of new solutions and engineering support to Piping and Instrumentation Diagrams.



### **Modular Design**

In order to make easier the components installation and to improve process reliability AMPO Engineering builds sub processes, miniplants and spools prepared for being installed directly at site. In close cooperation with the customer, plant process is analyzed, innovation is introduced and the module is constructed, checked and tested. It is sent ready for installation avoiding cleaning processes, commissioning tests and failure possibilities.

### **Training plan for qualified personnel**

Close cooperation with the customer leads to the drafting of a training plan for the plant's construction, operation and maintenance staff. This training schedule addresses aspects related to valves, motors, positioners, regulation, etc, focusing on preventive maintenance and valve know-how in order to ensure the plant is self-sufficient, insofar as possible. Training may be held on site or at AMPO Valve's facilities.



**“Our foundry, is fully in line with manufacturing processes, providing us with the best quality castings and service”**

Our foundry works together with our R+D+I team to create new developments and designs, a key factor in enabling AMPO to control the whole process, from start to finish.



## Production Processes and Products

We use a 5,000 kg arc furnace, a 5,000 kg AOD converter furnace and 7 induction furnaces with a capacity of 1,000 - 3,000 kg.

To be in a position to offer our customers the widest possible range of castings and best solutions, AMPO Foundry has 4 production lines, each of which uses the most advanced technologies so that we can satisfy all customer requirements.

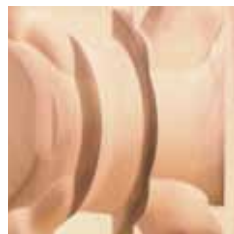

### Sand Moulding

Casting in sand chemically bonded with Phenolic Alkaline using wooden patterns. Manual moulding for large castings and semi-automatic moulding for medium-sized castings.

Weight range for castings: 50 - 5,000 kg.

Maximum moulding box size: 3000 x 3000



### Shell Moulding

Casting with heat-catalysed sand using metal patterns for small and medium-sized castings.

Weight range for castings: 5 - 50 kg.



### Replicast

High-precision ceramic-moulding process using aluminium patterns, capable of producing complex shapes unobtainable with shell-moulding.



### Centrifugally Spun

A casting process using a metal die which spins at high speed. Once the melt is in the die, the centrifugal force shapes the solidifying steel to the structure of the mould. We have facilities for both horizontal and vertical spinning. Horizontal spinning covers 100 - 645 mm. external diameter and vertical spinning 430 - 1200 mm. The maximum weight which can be obtained is 4000 kg.



## 2. General Overview of Cryogenic Service Valve

“As a result of over 30 years of experience in the manufacturing of cryogenic valves, AMPO Valves is the leading manufacturer of the high specification valves for the LNG market”

- 1 Company Profile
- 2 General Overview of Cryogenic Service Valve**
- 3 Why Choose AMPO Valves
- 4 Product Range
- 5 FES (Field Engineering Service)
- 6 Sales Network









Liquefied natural gas or LNG is natural gas (predominantly methane, CH<sub>4</sub>) that has been converted temporarily to liquid form for ease of storage or transport.

Liquefied natural gas takes up about 1/600th the volume of natural gas at a stove burner tip. It is odorless, colorless, non-toxic and non-corrosive. Hazards include flammability, freezing and asphyxia.

The liquefaction process involves removal of certain components, such as dust, helium, water, and heavy hydrocarbons, which could cause difficulty downstream. The natural gas is then condensed into a liquid at close to atmospheric pressure (Maximum Transport Pressure set around 25 kPa (3.6 psi)) by cooling it to approximately -163 °C (-260 °F).

The reduction in volume makes it much more cost-efficient to transport over long distances where pipelines do not exist. Where moving natural gas by pipelines is not possible or economical, it can be transported by specially designed cryogenic sea vessels (LNG carriers) or cryogenic road tankers.

LNG is principally used for transporting natural gas to markets, where it is regasified and distributed as pipeline natural gas. LNG offers an energy density comparable to petrol and diesel fuels and produces less pollution, but its relatively high cost of production and the need to store it in expensive cryogenic tanks have prevented its widespread use in commercial applications. It can be used in natural gas vehicles, although it is more common to design vehicles to use compressed natural gas.

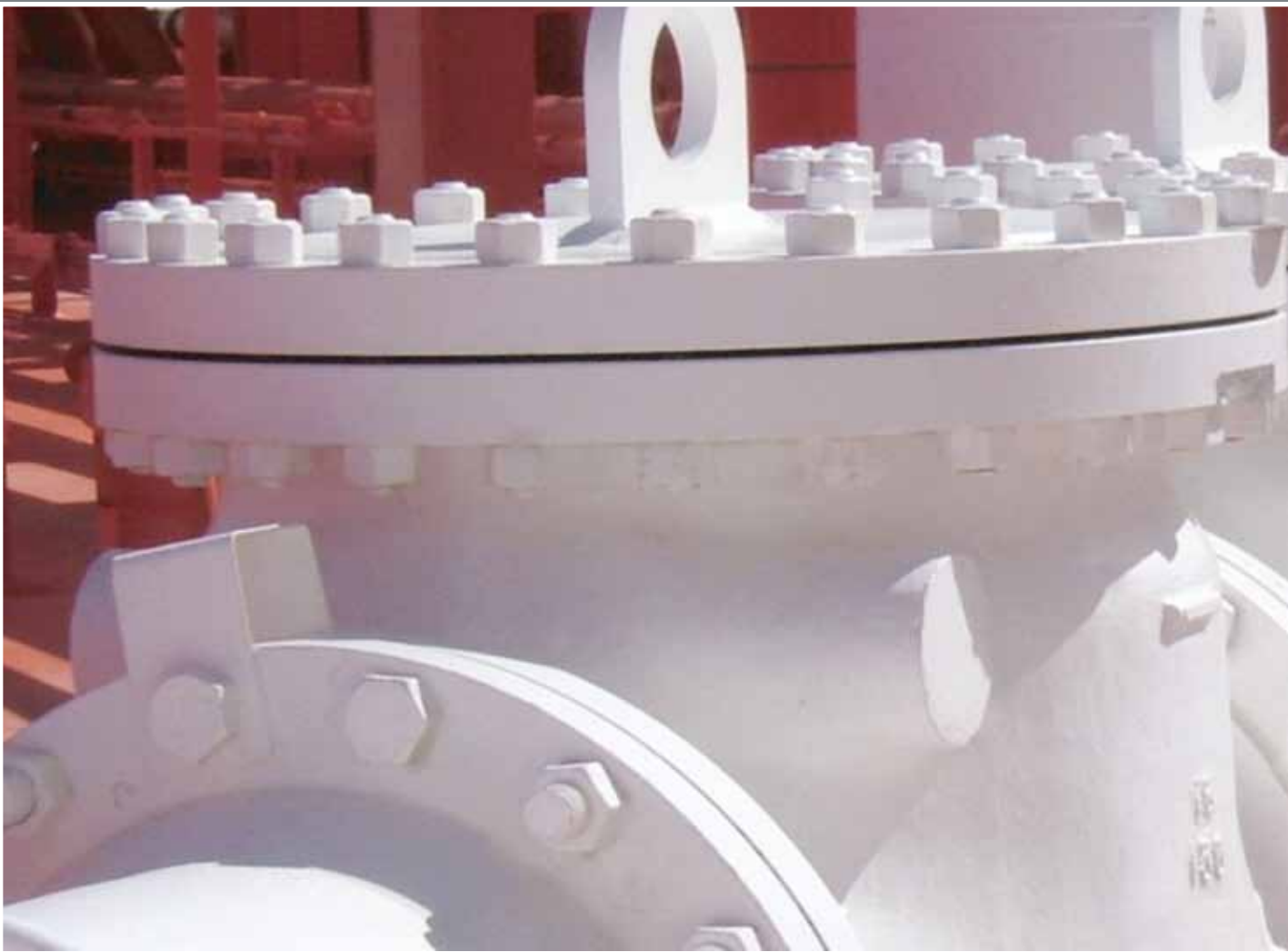

The density of LNG is roughly 0.41 to 0.5 kg/L, depending on temperature, pressure and composition, compared to water at 1.0 kg/L. The heat value depends on the source of gas that is used and the process that is used to liquefy the gas. The higher heating value of LNG is estimated to be 24 MJ/L at -164 degrees Celsius. This corresponds to a lower heating value of 21 MJ/L.

The natural gas fed into the LNG plant will be treated to remove water, hydrogen sulfide, carbon dioxide and other components that will freeze (e.g., benzene) under the low temperatures needed for storage or be destructive to the liquefaction facility. LNG typically contains more than 90% methane. It also contains small amounts of ethane, propane, butane and some heavier alkanes. The purification process can be designed to give almost 100% methane.

As a result of over 30 years of experience in the manufacturing of cryogenic valves, AMPO Valves is the leading manufacturer of the high specification valves for the LNG market, specially with top entry or split body cryogenic ball valves, and cryogenic gate, globe and check valves.



A man in a dark suit and red tie is looking at a large, complex industrial valve. The valve is made of metal and has several ports and a central mechanism. The background shows a factory or industrial setting with various structures and equipment.

### 3. Why choose AMPO Valves when you need Cryogenic Valves?

“For Cryogenic Service, the need of safe valves requires a highly skilled engineering service, best valve quality and best valve performance”

- 1 Company Profile
- 2 General Overview of Cryogenic Service Valve
- 3 Why Choose AMPO Valves**
- 4 Product Range
- 5 FES (Field Engineering Service)
- 6 Sales Network





### **3.1 Providing safe Valves in the new LNG market**

The recent growth and development of the LNG Market has created many opportunities for economic growth. However, as a consequence, this growth has increased the demand for equipment. This raises the question as to what equipment should be used ensuring that the number one priority in this sector always remains, safety through the supply of fully certified top-quality equipment.

With the growth of the LNG market the number of established engineering companies, operators and new owners (both via terminals and carriers) has also increased. As a result, all are looking to develop and increase their knowledge technically.



**“As experienced valve manufacturers, AMPO Valves has been a part of the LNG industry since the late 70’s, and what it notes is a clear loss of conscience of the risks inherent to the LNG process.”**

On occasions it may appear that the fast growth of the LNG sector has not allowed full research into the correct valve for the correct application. This can occur at all stages; liquefactions, transport and regasification. It could be the case even that the client or operator is offered what they believe might work as a cryogenic valve, but is in fact, only a standard valve with an extended bonnet. Calculations such as those necessary to determine the length required in order to ensure insulation on the extended bonnet, special seats, relief system, and the non destructive examination demand experience and knowledge.

There is only one way in which to explain the good safety results achieved thus far in the industry: compliance with stringent requirements for valve design and testing. Today, the low-cost valve manufacturers unfortunately do profit from the fast expansion of the market as well as from its new players, owners, as well as from engineering, procurement and construction (EPC) companies with short experience.

The ball valves in cryogenic service used to be exclusively of the top-entry type, trunnion-mounted and with butt weld (BW) ends to reduce the risks of leakage (pipe stress) to a minimum and give liability through time to the valve. Now, it is common to see ball valves of the side-entry type and floating balls with flanged ends. This results in many opportunities for seals to be damaged and leakage to be caused – first, through the flanges to the pipe and then through the flanges of the valve body itself – and a poor seat tightness. With the top-entry design associated with BW ends, the only possibility for leakage is through the bonnet. The trunnions of the ball give a lot of relief to the seats, which have a much longer life and reliability, whereas a floating ball imposes all the work to be done by the seats, and there are only two rings face the pressure.

## 3.2 AMPO Engineering

Our experience in the LNG world allowed AMPO to identify the needs and requirements of our customers. A new R+D+I team was created in collaboration with research centres for filling these needs up. This team tries to offer the most advanced technologies for the valve engineering.

The resources and efforts are driven to different valve stages: from process engineering until valve maintenance.

- Qualified team.
- Last generation work stations.
- 3D design programs, FEM and fluid simulation capacity.
- Support of Research centres.

### **Simulations of the valve behaviour under real operation conditions**

- Regulation: Flow rate / valve opening %
- Chattering: Minimum flow rate calculation for avoiding this problem. Real test in test bench.
- Valve erosion and wear: Internal geometry improvements.
- Deformation gauge test: Valve deformations under pressure and real measurements by gauges.
- Cavitation analysis.
- Etc.

### **Research centres in collaboration with AMPO engineering**

- INASMET TECNALIA: Materials. ([www.inasmet.es](http://www.inasmet.es))
- LBEIN TECNALIA: Materials. ([www.labein.es](http://www.labein.es))
- IKERLAN: Mechanical design. ([www.ikerlan.es](http://www.ikerlan.es))
- LORTEK: Welding processes. ([www.lortek.es](http://www.lortek.es))
- POLYMAT: Plastic material. ([www.sc.ehu.es/polymat](http://www.sc.ehu.es/polymat))
- TEKNIKER: Material characterization and coating processes. ([www.tekniker.es](http://www.tekniker.es))
- TECNUN: Fluid - mechanical calculations. ([www.tecnun.es](http://www.tecnun.es))
- CTI: Castings technology. ([www.castingstechnology.com](http://www.castingstechnology.com))
- Etc.

### **Modular design: spool and kit assemblies**

Spool fabrication is much easier at valve manufacturing stage and internal cleaning level and quality checks are more exhaustive. Valves, pipes, flanges, etc. are welded at AMPO, X-Ray shotted, pneumatically tested, painted and inspected so complete kits are sent to the customer for their installation.





### **P&ID analysis**

Our engineers work together with process engineers of our customers in order to develop a better plant design by means of P&ID analysis. It will improve the process by customizing valve designs to achieve the plant performance targets.

New products or modifications introduced in other projects could be recommended by AMPO.

Examples:

- Swing check valves with gearbox, pneumatic operation or damper.
- Stop check valves.
- BW/RF design valves.
- Valve kit assemblies, spool construction.
- Etc.





### 3.3 **Best Valve Quality**

**“Our motivated personnel, efficient production system and high-tech equipment enable AMPO to supply the best quality valves together with the highest production capabilities for ensuring on-time deliveries for the most demanding project schedules.”**





### 3.3.1 Manufacturing Process

High performance production equipment, such as CNC Valve-machining centers, Plasma hard-facing stations, 3D measuring machines, Special Coating Welding station, Ambient testing bench, Cryo testing bench, Fully automatic painting lines, Vacuum testing facilities, NDE bunkers (X-ray, magnetic particles, penetrant liquids) and an extremely clean assembly area enable us to provide our customers with high quality valves.





### 3.3.2 Quality Assurance System

AMPO Valves are well-known worldwide, with a reputation for reliability and high quality. The operativity and processes are implemented and governed by our quality assurance system, certified to ISO 9001, API Spec Q1 & 6D and SIL 3. and subjected to continuous review and audit by internal quality audits, third-party inspection agencies, and main engineering companies worldwide, demonstrating AMPO compliance with customer requirements and international standards. Internal Quality Control Personnel are highly-qualified to carry out Non-Destructive Examinations, such as X-ray, Dye Penetrant, Magnetic Particles and PAMI (positive alloy material identification).

AMPO Valves has efficient means to meet targets defined in the Strategic Plan. Our company and its product meet all legislative requirements, as well as international codes and standards.

We are equipped with the most modern installations and a highly-qualified human team, enabling us to offer the widest possible range of valves combining high standards in technology, quality and productivity, as well as tradition, experience and dependability, with an unrivalled reputation for quality and service.

Management based on the strictest quality standards allows AMPO to develop the product.



**“Every step from purchase order acknowledgment through procurement, NDE, machining, assembling, testing, painting and packaging is in accordance with regulations stipulated in ITP plans and all the processes are performed in house.”**



## 3.4 Best Valve Performance

### 3.4.1 Extended Bonnets

The length of the vapor column or bonnet refers to the minimum distance between the inside of the stuffing box throat and the top of the bonnet casting throat. Fluid temperature down to  $-165^{\circ}\text{C}$  (LNG) could be inside of valve and the extended bonnet, designed according to BS6364, has 2 principal aims:

- Allow the packing function in higher temperatures ( $-20^{\circ}\text{C}/-30^{\circ}\text{C}$ ).
- Valve's operability.

Packing gland arrangement is located at the top of extended bonnet. Operating torque at low temperature can be higher than at ambient temperature depending on valve type and design. Our stem design is sized taking in consideration this fact. Considering that valves can work at maximum differential pressure and minimum service temperature, gear is selected at maximum torque.

### 3.4.2 No Leakage

At cryogenic temperatures, this target is still more difficult than at ambient or high temperatures. Two important aspects have to be taken into account:

#### 1. Materials.

- Resilient materials at low temperatures.
- Good mechanical properties.
- Austenitic stainless steels.
- Soft seal: KEL-F, Vespel, Teflon, etc.

#### 2. Design.

- Internal leakage (ball/seat, wedge/seat).
- External leakage (body-bonnet gasket, packing, body-adaptor gasket).

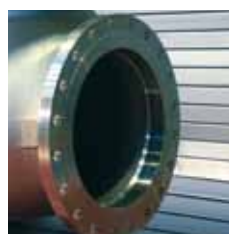
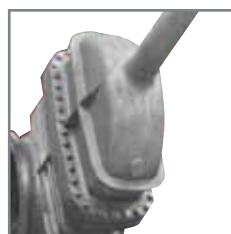



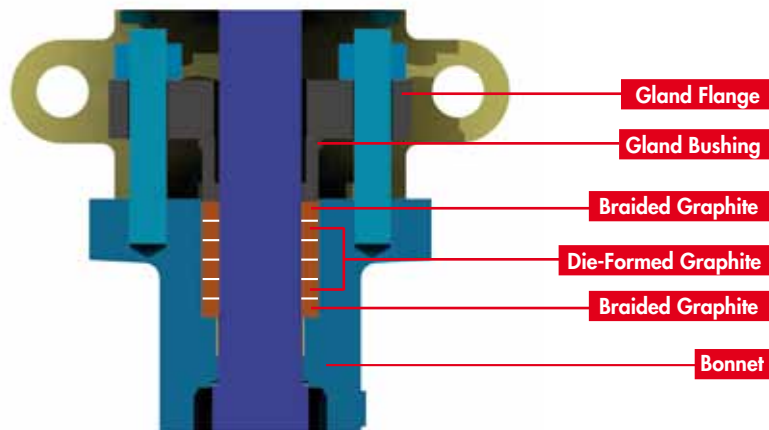

### 3.4.3 Stem Packing

A low emission stem packing is designed to ensure the low emission using a special material made of GRAPHOIL or any other material specified by the customer, combination of throat and flexible rings.

The high quality of the machined surfaces to obtain perfect wall surfaces avoids the emissions.

Special testing facilities designed by AMPO for testing different types of packings and for homologation processes.

### 3.4.4 Cavity Relief

All cryogenic valves with isolated cavities are always provided with cavity relief systems. Internal cavities have to be connected to the upstream or downstream pipe or in some special cases to a relief line. This prevents any build up of pressure in the body cavity of the closed valve due to a rise in temperature.

Valves are designed with preferred direction of flow and arrow is stamped on body to show these flow directions (optional).

3 standard options for the cavity relief are offered to the customers:

1. Cavity relief hole in the closure member (ball, wedge, disc,..) or seat.
2. Self relieving seats.
3. External vent, using a Pressure Relief Valve.

Any of them can be used but no one volume can be isolated from line security systems and the reliability of the relief system is one of the most important design figures of cryogenic valves.



### 3.4.5 Pressure Seal Design

Packing made by carbon filaments yards are braided and given a final external treatment with a mix of special lubricants. Carbon filaments keep its structure at high and low temperatures due to the good thermal conductivity which helps to stuffing box heat dissipation.

Graphite material gaskets with stainless steel filaments to became stronger the compression points, allows valve keeping very high pressures at any temperature. Also makes easier valve bonnet dismantling for maintenance purposes.

Design based on DIN-3840 standard, has been manufactured at AMPO during more than 28 years for high temperature applications and at the end of the nineties the design was adapted for cryogenic temperatures. The new design has been used with satisfactory results in many projects.



### 3.4.6 Antistatic Device

Soft seat valves that AMPO Valves manufacture as standard for cryogenic services are soft seated ball valves. The ball and the stem can charge statically during the operation. In order to avoid that, it is ensured a metallic contact between the stem and the body by a stainless steel ball pushed by a stainless steel spring.



### 3.4.7 Operation

Valves manufactured by AMPO Valves can be equipped with a variety of operating mechanisms, such as handwheel, impact handwheel, gear, electric actuator, hydraulic actuator or pneumatic actuator.

Motorized valves are supplied with the actuators installed and torque and position limits correctly adjusted.

Hand wheels are directly coupled to the stem and rise as the valve is opened. For opening the valve, handwheel must be rotated counterclockwise until interference is felt as the standard of AMPO.

Unless otherwise specified, gearing in most cases is sized to close with a maximum 35Kg rim pull on the gearing handwheel at a differential shut-off pressure equal to the class of the valve.

If the actual differential pressure is known, or a different rim pull is required, this information should be specified as the gearing size may change. The information required to custom size gearing is as follows:

- a) Operating conditions
- b) Differential shut-off pressure
- c) Maximum allowable handwheel rim pull
- d) Desired handwheel orientation.

Valve sizes from which gearbox is required, as standard:

SERVICE	VALVE TYPE	RATING					
		150	300	600	900	1500	2500
CRYOGENIC	GATE	12"	8"	6"	6"	3"	2 1/2"
CRYOGENIC	GLOBE	8"	6"	4"	3"	3"	1 1/2"
CRYOGENIC	TOP ENTRY BALL	2"	2"	2"	2"	2"	2"
CRYOGENIC	SPLIT BODY BALL	2"	2"	2"	2"	2"	2"
CRYOGENIC	END ENTRY BALL	3"	3"	3"	3"	3"	3"



Standard Gearbox position

The high speed of operations in modern industry and the necessity of making process plant operations automatic have increased the need for motor operated valves. Such applications include those where the valve:

1. Is too large or has too high a differential shut-off pressure for operation,
2. Is not accessible for manual operation,
3. Is part of a system requiring simultaneous operation of many valves,
4. Must be triggered from a remote location, as is often essential for emergency shut-off in hazardous areas.

Actuator manufacturer's instructions must be followed in case the valve is equipped with an actuator (electric, pneumatic or hydraulic). Torque, limit switches and additional parameters are adjusted in factory before shipment. Contact AMPO Valves before changing any parameters.

Any actuator mounted on an AMPO Valve's has a position indicator for indicating if the valve is open or closed. This position indicator depends on the actuator type; it can be a digital or a mechanical indicator.

Generally motor operating units, as illustrated are top-mounted. Side mounted units can be supplied where deemed necessary by valves manufacturer and actuators supplier.

All valves are furnished with special purpose yokes designed for the motor operating unit to be used, following ISO 5211.

Electric driven motor actuators consist of a special motor, a reduction gear, and necessary control components, all contained in a weather resisting enclosure, suitable for outdoor installation.

Moreover units can be supplied with all necessary contacts for local or remote indication. For hazardous locations, electric control units can also be furnished, on request, with flameproof or explosion proof enclosures, depending on specifications followed by the customer.



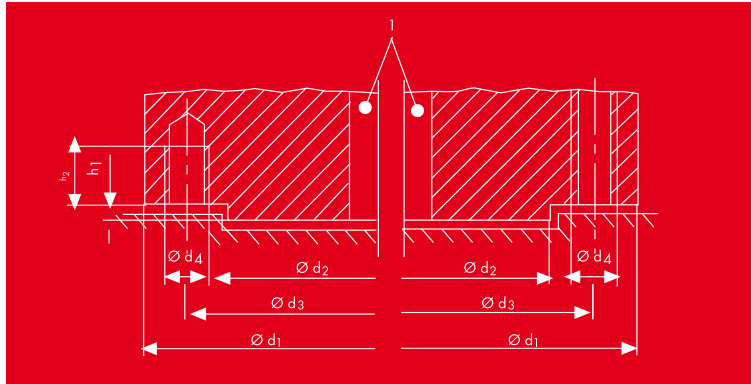

Standard actuator bracket connection dimensions according to ISO 5211

Dimensions in mm.

FLANGES TYPE	D <sub>1</sub>	D <sub>2</sub> FB	D <sub>3</sub>	D <sub>4</sub>	H <sub>1</sub> MAX.	H <sub>2</sub> MIN.	NUMBER OF SCREWS STUDS OR BOLTS
F03	46	25	36	M5	3	8	4
F04	54	30	42	M5	3	8	4
F05	65	35	50	M6	3	9	4
F07	90	55	70	M8	3	12	4
F10	125	70	102	M10	3	15	4
F12	150	85	125	M12	3	18	4
F14	175	100	140	M16	4	24	4
F16	210	130	165	M20	5	30	4
F25	300	200	254	M16	5	24	8
F30	350	230	298	M20	5	30	8
F35	415	260	356	M30	5	45	8
F40	475	300	406	M36	8	54	12
F60	686	470	603	M36	8	54	20

### 3.4.8 Drain and By-Pass connections

Valves designed by AMPO can be furnished with By-Passes in sizes shown in the following table. By-Passes are suitable for equalizing the pressure around main control valves used on steam and other fluids. The By-Pass unit has all connections socket welded to make a strong tight joint.

When valves are ordered with By-Pass, this unit shall be installed at the side of the main valve with stem pointing vertically upward. It can also be installed to the bottom of the main valve or any other special location that has to be sketched with the order.

By-Pass assemblies are generally formed of small globe valve interconnected with main valve by two lengths of piping located on each side of the main valve wedge or disc.

For cryogenic services, By-Pass devices are being ordered for ball valves in order to avoid welding process at site and consequently, improve installation times and quality.

**NOMINAL SIZE OF MAIN VALVE**

**UP TO 4"      6"-8"      10"-20"      24 AND ABOVE**

**NOMINAL SIZE OF BY-PASS VALVE**

**1/2"      3/4"      1"      2"**

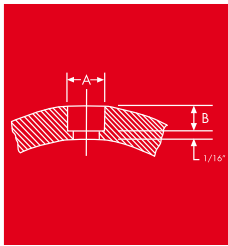

**SOCKET WELDING FOR DRAINS**

MAIN VALVE NOMINAL SIZE (inch)	2 to 4		5 to 8		10up		
	3/8	1/2	3/4	1	1-1/4	1-1/2	2
NOMINAL SIZE OF DRAIN (inch)	0.690	0.855	1.065	1.330	1.675	1.915	2.406
MIN. DIAMETER OF SOCKET, A (inch)	0.19	0.19	0.25	0.25	0.25	0.25	0.31
MIN. DEPTH OF SOCKET, B (inch)							

All dimensions given in inches.  
See introductory Notes 6.11.2.1, 6.11.3, 6.11.4, ASME B 16.5.  
See MSS-SP-45.

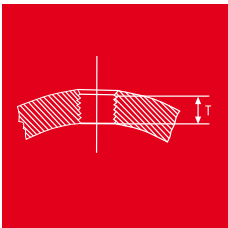

**THREAD LENGTH FOR DRAIN TAPPING**

MAIN VALVE NOMINAL PIPE (inch)	2 to 4		5 to 8		10up		
	3/8	1/2	3/4	1	1-1/4	1-1/2	2
NOMINAL SIZE OF DRAIN (inch)	0.41	0.53	0.55	0.68	0.71	0.72	0.76
LENGTH OF THREAD T (inch)							

All dimensions given in inches.  
See introductory Notes 6.11.1, 6.11.3, 6.11.4, ASME B 16.5.  
In no case shall the effective length of thread, T be less than that shown in the table above.  
These lengths are equal to the effective thread length of American Standard External Pipe Threads (ASME B 2.1).  
See MSS-SP-45.

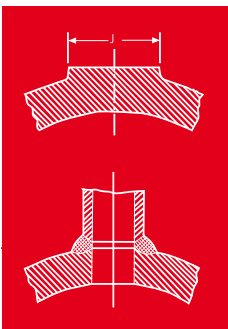

**BUTT WELDING FOR DRAINS**

MAIN VALVE NOMINAL PIPE (inch)	2 to 4		5 to 8		10up		
	3/8	1/2	3/4	1	1-1/4	1-1/2	2
NOMINAL SIZE OF DRAIN (inch)	1.25	1.50	1.75	2.13	2.50	2.75	3.38
DIAMETER OF BOSS J (inch)							

See introductory Note 6.11.2.2, ASME B 16.5.  
See MSS-SP-45.  
All dimensions given in inches.  
See introductory Notes 6.11, ASME B 16.5.  
See MSS-SP-45.

## Method of Designating Location of tapped Holes for Drains

### Gate Valves

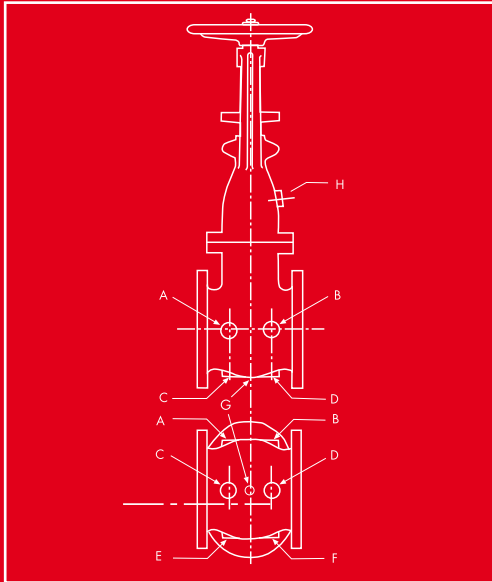

### Globe Valves

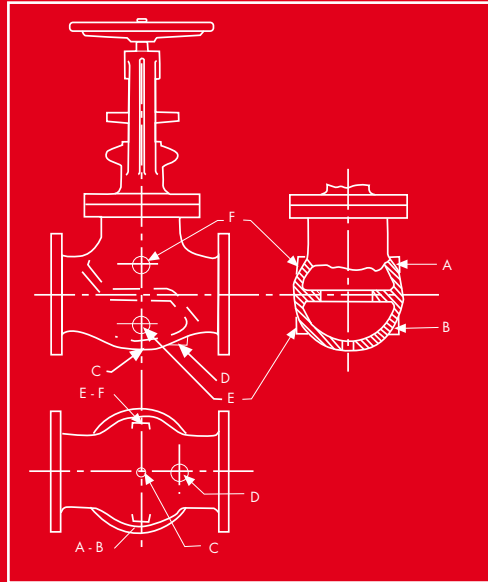

### Angle Valves

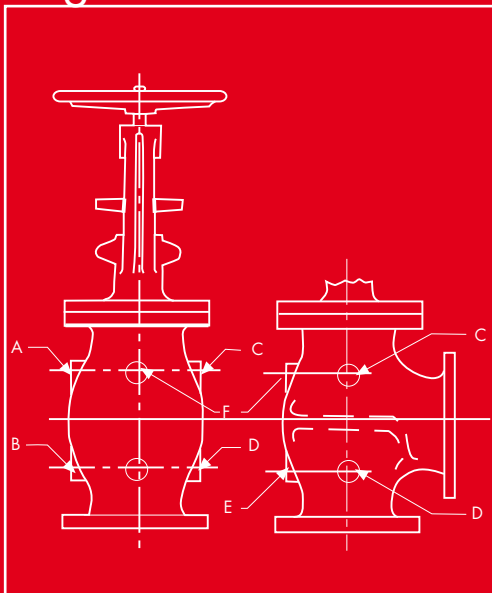

### Swing Check Valves

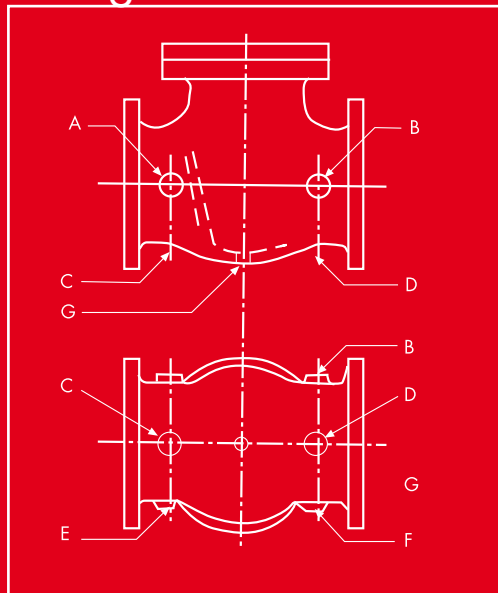

Note: The above sketches represent valves with symmetrical shapes. Sketches are illustrative only and do not infer design. See introductory Note 6.11, ASME B 16.5.

### 3.4.9 Dimensions of welded and seamless pipe

All dimensions are in inches.

- Schedule 5 S and 10 S wall thicknesses do not permit threading in accordance with ASME B 2.1.
- These do not conform to ASME B 36.10

### Stainless steel pipe

DIMENSIONS IN INCHES ASME B 36.19

NOMINAL PIPE SIZE	OUTSIDE DIAMETER	NOMINAL WALL THICKNESS			
		Sched. 5S	Sched. 10S	Sched. 40S	Sched. 80S
1/8	0.405	-	0.049	0.068	0.095
1/4	0.540	-	0.065	0.088	0.119
3/8	0.675	-	0.065	0.091	0.126
1/2	0.840	0.065	0.083	0.109	0.147
3/4	1.050	0.065	0.083	0.113	0.154
1	1.315	0.065	0.109	0.133	0.179
1 1/4	1.660	0.065	0.109	0.140	0.191
1 1/2	1.900	0.065	0.109	0.145	0.200
2	2.375	0.065	0.109	0.154	0.218
2 1/2	2.875	0.083	0.120	0.203	0.276
3	3.500	0.083	0.120	0.216	0.300
3 1/2	4.000	0.083	0.120	0.226	0.318
4	4.500	0.083	0.120	0.237	0.337
5	5.563	0.109	0.134	0.258	0.375
6	6.625	0.109	0.134	0.280	0.432
8	8.625	0.109	0.148	0.322	0.500
10	10.750	0.134	0.165	0.365	0.500
12	12.750	0.165	0.180	0.375*	0.500*





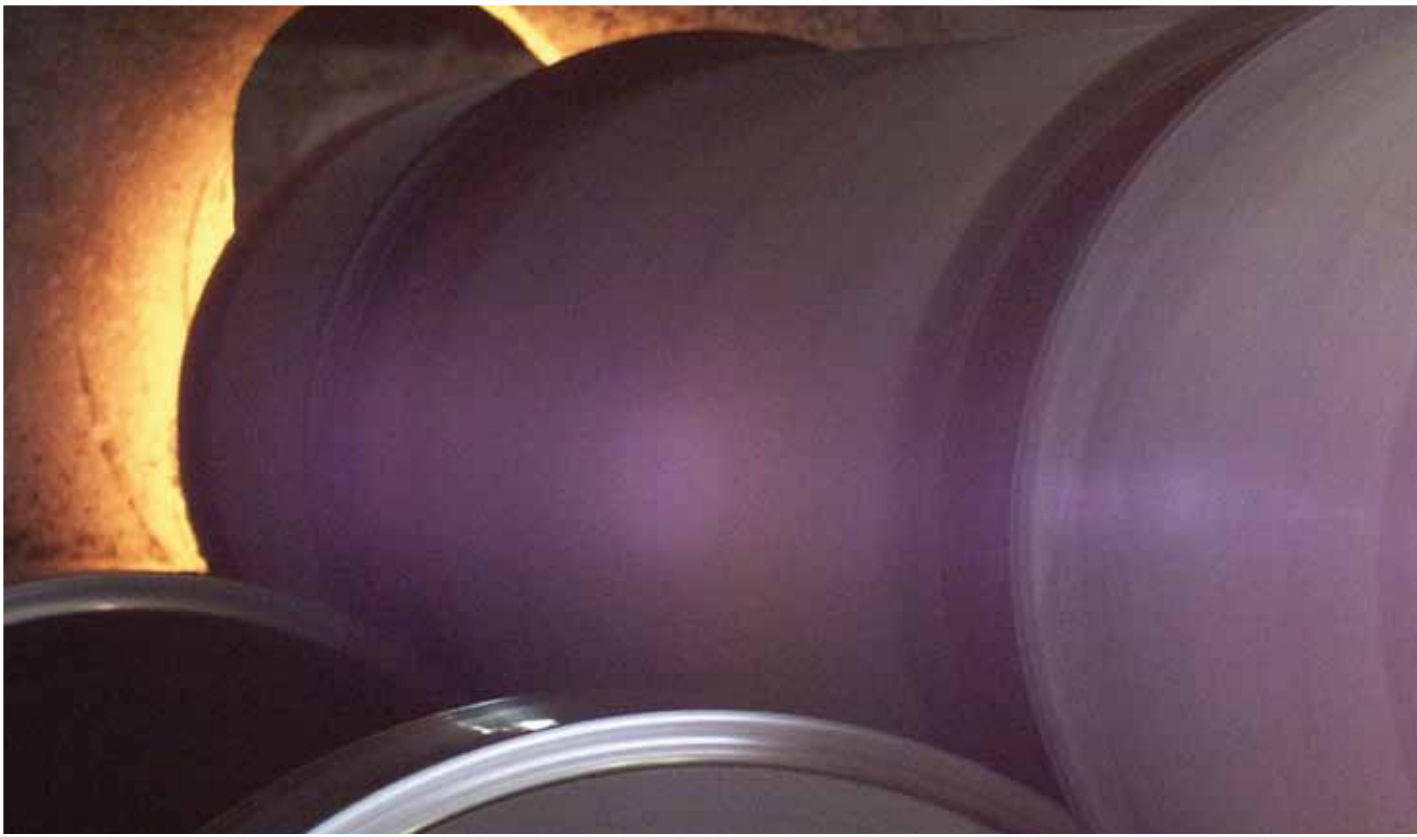

## Carbon and Alloy Steel Pipe

**NOMINAL PIPE SIZE**

**OUTSIDE DIAMETER**

**ASME B 36.10**

**APPENDIX B**

### NOMINAL WALL THICKNESS

		NOMINAL WALL THICKNESS		
		Standard wall	Extra strong Wall	Double extra strong wall
1/8	0.405	0.068	0.095	-
1/4	0.540	0.088	0.119	-
3/8	0.675	0.091	0.128	-
1/2	0.840	0.109	0.147	0.294
3/4	1.050	0.113	0.164	0.308
1	1.315	0.133	0.179	0.358
1 1/4	1.660	0.140	0.191	0.382
1 1/2	1.900	0.145	0.200	0.400
2	2.375	0.154	0.218	0.438
2 1/2	2.875	0.203	0.276	0.552
3	3.600	0.216	0.300	0.600
3 1/2	4.000	0.226	0.318	-
4	4.500	0.237	0.337	0.674
5	5.563	0.258	0.375	0.750
6	6.625	0.280	0.432	0.884
8	8.625	0.322	0.500	0.875
10	10.750	0.365	0.500	-
12	12.750	0.375	0.500	-
14	14.000	0.375	0.5000	-
16	16.000	0.375	0.500	-
18	18.000	0.375	0.600	-
20	20.000	0.375	0.500	-
24	24.000	0.375	0.500	-
30	30.000	-	-	-



Dimensions in inches ASME B 36.10

**ASME B 36.10**

**APPENDIX B**

**NOMINAL WALL THICKNESS**

Sched.10	Sched.20	Sched.30	Sched.40	Sched.60	Sched.80	Sched.100	Sched.120	Sched.140	Sched.180
-	-	-	0.068	-	0.095	-	-	-	-
-	-	-	0.088	-	0.119	-	-	-	-
-	-	-	0.091	-	0.126	-	-	-	-
-	-	-	0.109	-	0.147	-	-	-	0.187
-	-	-	0.113	-	0.154	-	-	-	0.218
-	-	-	0.133	-	0.179	-	-	-	0.250
-	-	-	0.140	-	0.191	-	-	-	0.250
-	-	-	0.145	-	0.200	-	-	-	0.281
-	-	-	0.154	-	0.218	-	-	-	0.343
-	-	-	0.203	-	0.276	-	-	-	0.375
-	-	-	0.216	-	0.300	-	-	-	0.438
-	-	-	0.226	-	0.318	-	-	-	-
-	-	-	0.237	-	0.337	-	0.438	-	0.531
-	-	-	0.258	-	0.375	-	0.500	-	0.625
-	-	-	0.280	-	0.432	-	0.562	-	0.718
-	0.250	0.277	0.322	0.406	0.500	0.593	0.718	0.812	0.906
-	0.250	0.307	0.365	0.500	0.593	0.718	0.843	1.000	1.125
-	0.250	0.330	0.408	0.562	0.687	0.843	1.000	1.125	1.312
0.250	0.312	0.375	0.438	0.593	0.750	0.937	1.093	1.250	1.406
0.250	0.312	0.375	0.500	0.656	0.843	1.031	1.218	1.438	1.593
0.250	0.312	0.438	0.562	0.750	0.937	1.158	1.375	1.562	1.781
0.250	0.375	0.500	0.593	0.812	1.031	1.281	1.500	1.750	1.968
0.250	0.375	0.562	0.687	0.968	1.218	1.531	1.812	2.062	2.343
0.312	0.500	0.625	-	-	-	-	-	-	-

### 3.4.10 Gasket Surface Finishes

AMPO Valves designed for bolted connection, when supplied with raised or flat face, may have any type of gasket surface finish required.

Gasket surface, unless otherwise specified by the purchaser, will be machined with a STOCK FINISH.

This surface, together with other gasket surface finished which can be furnished to order, is described as follows:

**1. STOCK FINISH:** The most widely used of any gasket finish, because, it is suitable for practically all ordinary service conditions. This is a continuous spiral groove. Flanges sizes 12" and smaller, are produced with a 1/16" round-nosed tool at feed of 1/32" per revolution. For sizes 14" and larger, the finish is made with a 1/8" round - nosed tool at feed of 3/64" per revolution.

**2. SPIRAL SERRATED OR PHONOGRAPHIC:** This finish is produced by using a 90° included-angle (V) tool, making a spiral groove 1/64" deep with a feed of 1/32".

**3. CONCENTRIC SERRATED:** This finish is produced by using a 90° included angle (V) tool, making concentric groove 1/64" deep and 1/32" apart.

**4. SMOOTH FINISH:** This finish is produced by several shapes of tools cutting at speeds and feeds which leave no definite tool marks apparent to the naked eye.

#### SUPPLEMENTARY INFORMATION:

See ASME B 46-1 and BS 1134 about surface texture terms and definitions. AMPO Valves may have any type of surface finish required, according to the following values.

- Arithmetical Average (AA)
- Arithmetical Mean Deviation (Ra) (previously known as CLA)
- Root Mean Square (RMS).

The side walls of the Ring-Joint groove shall be 63 micro-inch maximum roughness. Large male - female standard finish of gasket surface is serrated, either spiral or concentric, with 32 serrations per inch. Small male-female and tongue groove standard finish of gasket surface is 125 micro-inch maximum roughness.

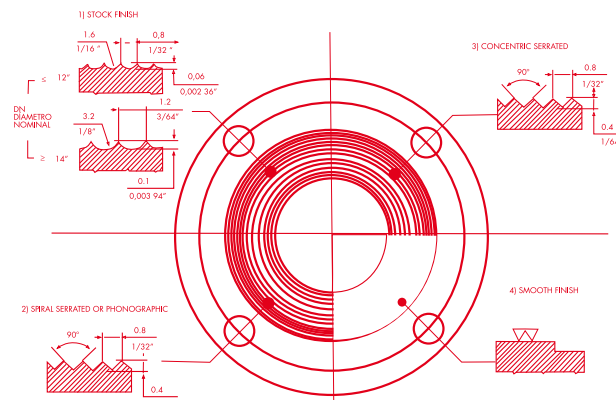



### 3.4.11 Ring numbers for Ring Joint flanges

NOMINAL PIPE SIZE	1/2	3/4	1	1 1/4	1 1/2	2	2 1/2	3	3 1/2	4
150 LB.	-	-	R15	R17	R19	22	R25	R29	R33	R36
300-400-600 LB.	R11	R13	R15	R18	R20	R23	R26	R31	R34	R37
900 LB.	-	-	-	-	-	-	-	R31	-	R37
1500 LB.	R12	R14	R16	R18	R20	R24	R27	R35	-	R39
2500 LB.	R13	R16	R18	R21	R23	R26	R28	R32	-	R38

NOMINAL PIPE SIZE	5	6	8	10	12	14	16	18	20	24
150 LB.	R40	R43	R48	R52	R56	R59	R64	R68	R72	R76
300-400-600 LB.	R41	R45	R49	R53	R57	R61	R65	R69	R73	R77
900 LB.	R41	R45	R49	R53	R57	R62	R66	R70	R74	R78
1500 LB.	R44	46	R50	R54	R58	R63	R67	R71	R75	R79
2500 LB.	R42	R47	R51	55	R60	-	-	-	-	-

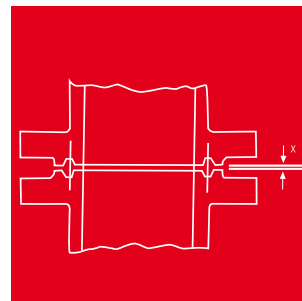
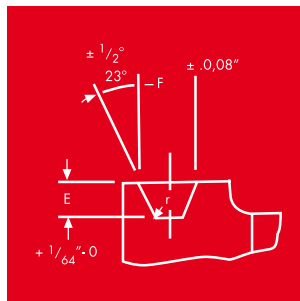
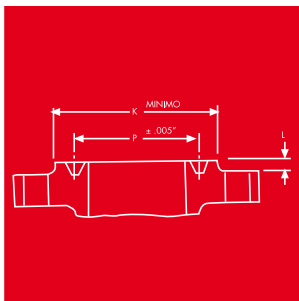

A close-up photograph of a metallic valve component, likely made of stainless steel or a similar alloy. The surface is highly reflective and shows signs of wear. In the upper right corner, the numbers '2' and '1' are embossed. In the lower right corner, the letter 'P' is embossed. The lighting creates strong highlights and shadows, emphasizing the texture and form of the metal.

## 4. Product Range

“AMPO Valves brings the widest Cryogenic Ball, Gate, Globe & Check valve production range in the market”

- 1 Company Profile
- 2 General Overview of Cryogenic Service Valve
- 3 Why Choose AMPO Valves
- 4 Product Range**
- 5 FES (Field Engineering Service)
- 6 Sales Network

50  
ROYAL  
CF8M  
I



## 4.1 Cryogenic Ball valves

Ball valve is the ideal valve for perfect sealing requirements, for tie ins, maintenance isolations, line closure etc. AMPO Valves is the reference in cryogenic ball valves due to our experience, quality and customer satisfaction ratio. As a result of more than 30 years manufacturing cryogenic top entry, split body and end entry cryogenic ball valves, zero leak quality class has been achieved. Around 25.000 cryogenic tests have been carried out at our testing facilities and in total, more than 250.000 cryogenic ball valves have been manufactured.

### Materials, Ampo Standard Sealing Design...

Having our own foundry, AMPO Foundry, and considering our long experience we have had the option of testing all kind of alternative materials, which gives the security that the ones used in AMPO Valves are the best ones and special designs have been prepared and tested for each material.

#### CASTING PIECES:

ASTM A 351 Gr CF8  
ASTM A 351 Gr CF8M  
ASTM A 351 Gr CF3  
ASTM A 351 Gr CF3M  
ASTM A 351 Gr CF8C

#### STEM MATERIALS:

ASTM A 479 Gr 304  
ASTM A 479 Gr 304L  
ASTM A 479 Gr 316  
ASTM A 479 Gr 316L  
ASTM A 564 TYPE 630 H1150D  
NITRONIC 50<sup>®</sup>  
MONEL K-500<sup>®</sup>

#### SEAT MATERIALS:

PCTFE  
RPTFE  
VESPEL SP-21<sup>®</sup>

#### SEAT GASKET MATERIALS:

PCTFE  
PTFE  
Graphite

Any kind of bolting material required by each specification and each process condition.

### Ampo standard sealing design

A small hole of 3mm diameter is drilled on one of the seat rings or on the ball. This hole is usually in the upstream side and the cavity pressure is relieved in case of overpressure, through that. Thus, closure in both directions has to be achieved in the downstream seat and that is the key point of designs developed by AMPO Valves.

The simplicity of the relieving system and the reliability of the sealing device makes this design to be the one chosen by the majority of the end users.



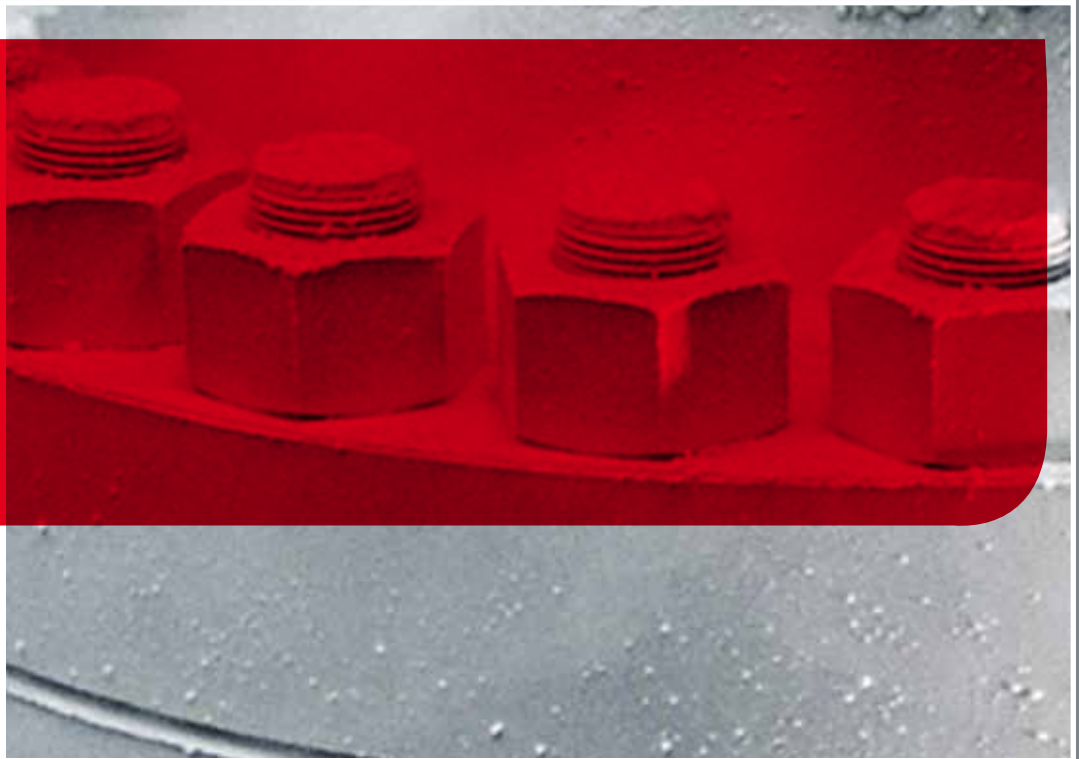

### **Double block and single bleed valves:**

Upstream seal is a unidirectional floating seat ring that closes in the preferential direction and relieves the cavity if an overpressure is achieved inside. Downstream seat is a tight shut off seat that ensures the closure in both directions.

This kind of valves has a preferred direction where a double block is achieved and the bleed is carried out always through the upstream seat avoiding external devices.

When the valve is closed, the drain installed at the bottom of the valve can be opened in order to check that the upstream seat is closing correctly.

### **External vent double block valves:**

If a double block seal is required in order to allow the leak detection through a drain connection and a simple relief device is preferred, this design fulfils both conditions. Upstream and downstream seats are bidirectional so a double seal is achieved in both directions.

In case of overpressure, the fluid is relieved through a relief valve or shut of valve installed to the main valve bonnet. When the valve is closed, the secondary valve is closed and the drain has to be opened. Thus, it is assured that the first seal is closing and any work can be carried out in safe conditions.

### **Self relieving seat design:**

In that case, each seat closes in its direction. The common standard double block and bleed design has been translated to cryogenic temperatures. For cavity relieves, the floating seat ring is displaced forwards the ball and the cavity is connected to the line. Usually, one of the seat rings floats at smaller pressure for conducting the flow to its side.

## 4.1.1. Cryogenic Top Entry - Ball Valves

Top entry cryogenic ball valves are basically used in liquefaction plants, LNG receiving terminals, transportation, chemical plants and other installations where low temperature service is needed and high security measures are required. The top entry design makes the valve maintainable at site and inline so normally, these valves are butt welded valves and consequently potential external leak points are dramatically reduced.

All internal pieces can be removed and replaced keeping the valve in line so the maintenance of the valves is one of the key points for the selection of this design type.

### 4.1.1.1

#### FLOATING TYPE CRYOGENIC TOP ENTRY BALL VALVE

Seal element is static and shut off is produced by line pressure acting to the ball, pushing it against the seating ring.

**Standards:** API, BS, MSS, ASME, ASTM, DIN

**Classes:** 150 lbs up to 2500 lbs

**Sizes:** 1/2" up to 6"

**Construction:** Extended bonnet (Gas column). Bolted bonnet. Full and reduced bore. Flanged, butt weld ends and both. Manual and actuated (pneumatic/electric/hydraulic). Fire safe. Soft and metal seats.

**Temperature:** Down to -196°

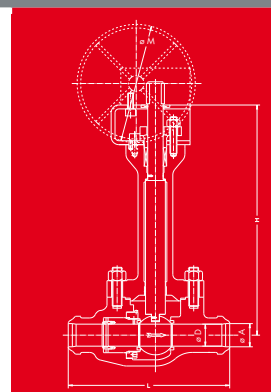

#### RATING

150#

300# - 2500#

Standard valve designs. If any alternative is required check it with AMPO VALVES

#### UP TO SIZE

6"

2"

#### EXAMPLE



#### 4.1.1.2

### TRUNNION TYPE CRYOGENIC TOP ENTRY BALL VALVE

Ball is static and sealing element is dynamic. Shut off is produced by a combination of pushing seat ring against ball by means of driving nuts and line pressure effect.

**Standards:** API, BS, MSS, ASME, ASTM, DIN

**Classes:** 150 lbs up to 2500 lbs

**Sizes:** 3" up to 56"

**Construction:** Extended bonnet (Gas column). Bolted bonnet. Full and reduced bore. Flanged, butt weld ends and both. Manual and actuated (pneumatic/electric/hydraulic). Fire safe. Soft and metal seats.

**Temperature:** Down to -196°

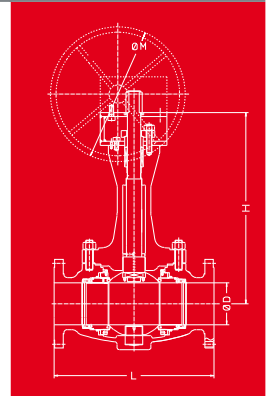

#### RATING

#### SIZE

150#

8" - 56"

300# - 900#

3" - 48"

1500# - 2500#

3" - 36"

Standard valve designs. If any alternative is required check it with AMPO VALVES



#### EXAMPLES

## 4.1.2. Cryogenic Split Body - Ball Valves

Split body cryogenic ball valves are basically used in Liquefaction plants, LNG receiving terminals, transportation, chemical plants and other installations where low temperature service is needed. Maintenance works inside valve can not be carried out while valves are installed so these valves use to be flanged end valves.

All internal pieces can be removed and replaced very easily once the valve has been taken out from line.

### 4.1.2.1

#### FLOATING TYPE CRYOGENIC SPLIT BODY BALL VALVE

<b>Standards:</b>	API, BS, MSS, ASME, ASTM, DIN
<b>Classes:</b>	150 lbs up to 2500 lbs
<b>Sizes:</b>	1/2" up to 4"
<b>Construction:</b>	Extended bonnet (Gas column). Bolted bonnet. Full and reduced bore. Flanged ends. Manual and actuated (pneumatic/electric/hydraulic). Fire safe. Soft seats.
<b>Temperature:</b>	Down to -196°

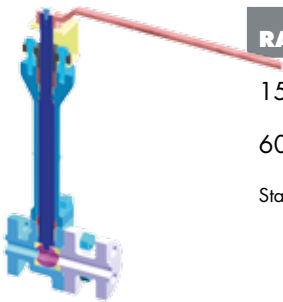
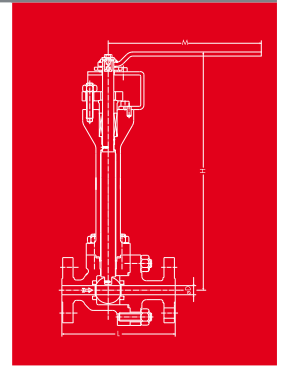

#### RATING

150# - 300#

600# - 2500#

Standard valve designs. If any alternative is required check it with AMPO VALVES

#### UP TO SIZE

4"

1 1/2"

#### EXAMPLE

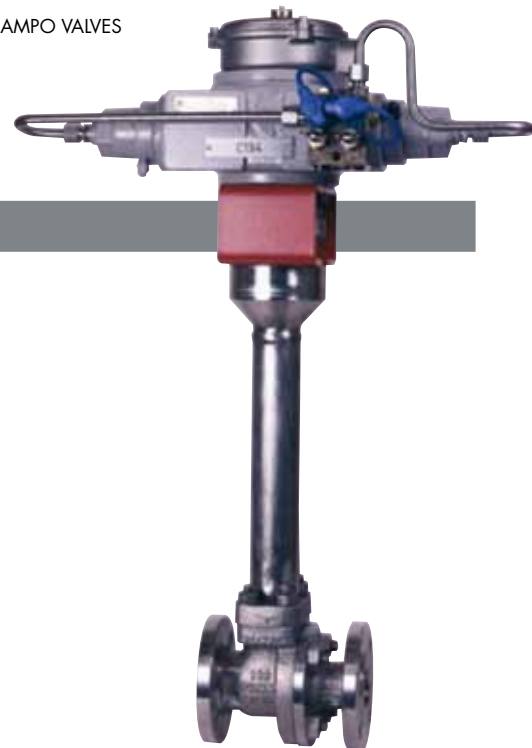

#### 4.1.2.2

### TRUNNION TYPE CRYOGENIC SPLIT BODY BALL VALVE

Ball is static and sealing element is dynamic. Shut off is produced by a combination of pushing seat ring against ball by means of driving nuts and line pressure effect.

**Standards:** API, BS, MSS, ASME, ASTM, DIN

**Classes:** 150 lbs up to 2500 lbs

**Sizes:** 2" up to 56"

**Construction:** Extended bonnet (Gas column). Bolted bonnet. Full and reduced bore. Flanged ends. Manual and actuated (pneumatic/electric/hydraulic). Fire safe. Soft seats.

**Temperature:** Down to -196°

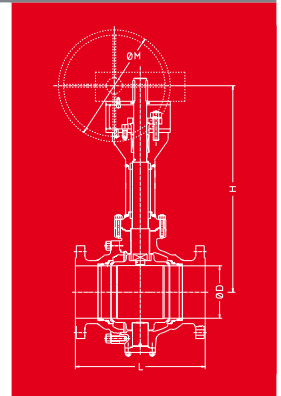

#### RATING

150# - 300#

300# - 900#

1500# - 2500#

#### SIZE

6" - 56"

2" - 48"

2" - 36"

Standard valve designs. If any alternative is required check it with AMPO VALVES

#### EXAMPLE



## 4.1.3. Cryogenic End Entry - Ball Valves

End entry cryogenic ball valves are basically used in Liquefaction plants, LNG receiving terminals, transportation, chemical plants and other installations where low temperature service is needed. Maintenance works inside valve can not be carried out while valves are installed so these valves use to be flanged end valves.

One of the flanges of the split body valves is avoided so one possible leak point is eliminated and a very compacted design is achieved.

### 4.1.3.1

#### FLOATING TYPE CRYOGENIC END ENTRY BALL VALVE

Seal element is static and shut off is produced by line pressure acting to the ball, pushing it against the seating ring.

**Standards:** API, BS, MSS, ASME, ASTM

**Classes:** 150 lbs up to 2500 lbs

**Sizes:** 1/2" up to 6"

**Construction:** Extended bonnet (Gas column). Bolted bonnet. Floating Type. Full and reduced bore. Flanged ends. Manual and actuated (pneumatic/electric/hydraulic). Fire safe. Soft seats.

**Temperature:** Down to -196°

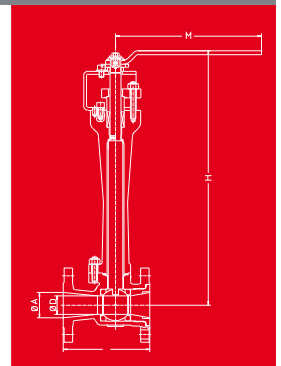

#### RATING

150# - 300#

600# - 2500#

#### UP TO SIZE

6"

3"

Standard valve designs. If any alternative is required check it with AMPO VALVES

#### EXAMPLE

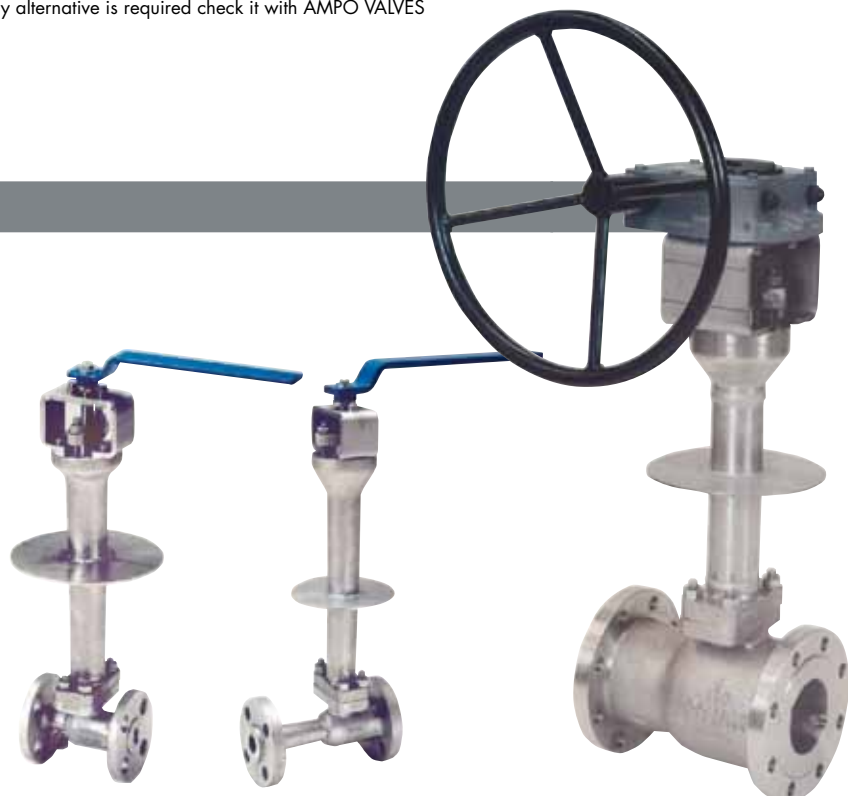



## 4.2 Cryogenic Gate valves

During the experience of more than 30 years designing and manufacturing cryogenic gate valves, the design and production have reached a great reliability and a perfect sealing quality. The production range has been increased step by step up to 72 inch valves and the manufacturing of small valves is still very competitive due to process improvements and productivity achieved by AMPO Valves.

All gate valves manufactured by AMPO Valves are rising stem type, outside screw and yoke design and flexible wedge design. Apart from that all the rest design parameters can be adapted to the customer requirements by our engineering teams. That flexibility allows us being the reference in very special applications and special valve requirements.

### Valve range and alternatives:

Gate valve range goes from 150# up to 2500# and from 2" up to 72" and can be bolted bonnet (BB) or pressure seal design (PS) depending on pressure ratings and project specifications.

Body minimum wall thickness can be defined by API 600 standard, by ASME B.16.34 standard or by ISO 12516.

### Sealing system:

Standard cryogenic gate valves normally have a 3mm vent hole on the wedge upstream side that relieves the cavity in case of overpressure. Thus, standard cryogenic gate valves are unidirectional valves. Pressure deforms the flexible wedge and it is introduced through the upstream seat and cavity vent to the internal cavity. Inside, pushes the wedge downstream face against the seat and gets the closure.

If bidirectional cryogenic valves are required, external relief system shall be used. In that case, the vent hole is avoided and downstream seat makes the seal in each direction. Cavity is vented in case of overpressure through a relief valve connected to the valve bonnet inside cavity and besides the packing.

On cryogenic gate valves, the back seat is integral with the bonnet. The conical back seat plug is integral with the stem and seals when the valve is in the fully open position. This allows re-packing of the gland under full service conditions.





### **Design and construction:**

The design and construction of the cryogenic range of AMPO Valves, is based on the requirements and codes of practice of the American and British Petroleum, Petrochemical and Power Industries.

The standards and codes used are from the following institutions:

- API American Petroleum Institute.
- ASME American Society of Mechanical Engineers.
- ASTM American Society for Testing Materials.
- BSI British Standards Institution.
- MSS Manufacturers Standardization Society.

Gate valves are designed to comply with the following standards:

- BS1414.
- API 600.
- ASME B16.10.
- ASME B16.25.
- ASME B16.5.
- ASME B16.47.
- ASME B.16.34.
- BS 6364.
- ASME VIII.



### **Materials:**

Our own foundry allows us controlling the whole process of the high quality austenitic stainless steel valves for bodies, bonnets, etc. For stem materials, apart from the common stainless steel laminated or forged material such as Gr304, 304L, 316, 316L, 347, 347L etc. high performance stainless steel material are used, such as S17400, NITRONIC 50<sup>®</sup>, MONEL K500<sup>®</sup>, etc.

### **Casting pieces:**

- ASTM A 351 Gr CF8
- ASTM A 351 Gr CF8M
- ASTM A 351 Gr CF3
- ASTM A 351 Gr CF3M
- ASTM A 351 Gr CF8C

### **Stem materials:**

- ASTM A 479 Gr 304.
- ASTM A 479 Gr 304L.
- ASTM A 479 Gr 316.
- ASTM A 479 Gr 316L.
- ASTM A 564 TYPE 630 H1150D.
- NITRONIC 50.<sup>®</sup>
- MONEL K-500.<sup>®</sup>

Valve wedge is normally hard faced by a stellite6 overlay and body seat is a integrated seat but any kind of combination can be manufactured. Any kind of bolting material required by each specification and each process condition.

## GATE VALVES

**Standards:** API, BS, MSS, ASME, ASTM

**Classes:** 150 lbs up to 2500 lbs

**Sizes:** 2" up to 72"

**Construction:** Bolted bonnet and Pressure seal. Extended bonnet (Gas column). Flanged and butt weld ends. Manual and motor-operated. Metal seats.

**Temperature:** Down to -196°

## BOLTED BONNET

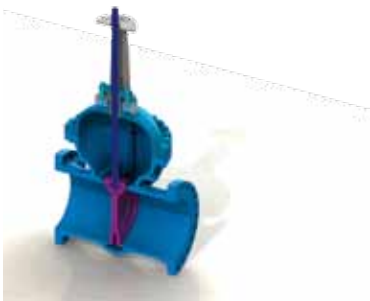
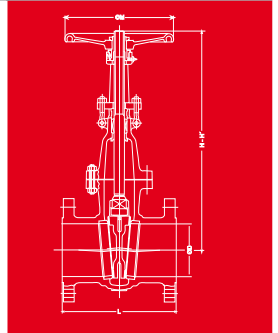

## EXAMPLE



## 4.3 Cryogenic Globe valves

Cryogenic globe valves are designed exclusively for the handling of cryogenic liquids on bulk storage tanks, transports, and pipelines. These globe valves are used for throttling services, provide positive shut off and offer a long, low-maintenance service life.

The valves have been carefully designed and constructed to get maximum rigidity and reliability for long service life and trouble free even under heavy-duty operation.

### Valve range and alternatives:

Cryogenic globe valve range goes from 150# up to 2500# and from ½" up to 72" and can be bolted bonnet (BB) or pressure seal design (PS) depending on pressure ratings and project specifications.

At customer's request, different configurations can be manufactured:

- Discs can be fitted as parabolic design.
- Body design can be standard pattern, angle pattern type or straight pattern type.
- Valve can be design as a stop check valve. A stop check valve design has the advantages of the check valve, working as a non-return when it is in open position and the advantage of the globe valve for shut off.

### Sealing system:

AMPO Valve's globe valves are built with metal to metal technology. On cryogenic globe valves, the seats are integral with the body and the disc has a stellite overlay in order to hardener.

On cryogenic globe valves, the back seat is integral with the bonnet. The conical back seat plug is integral with the stem and seats when the valve is in the fully open position. This allows re-packing of the gland under full service conditions.

### Design and construction:

The design and construction of the cryogenic range of AMPO Valves, is based on the requirements and codes of practice of the American and British Petroleum, Petrochemical and Power Industries.

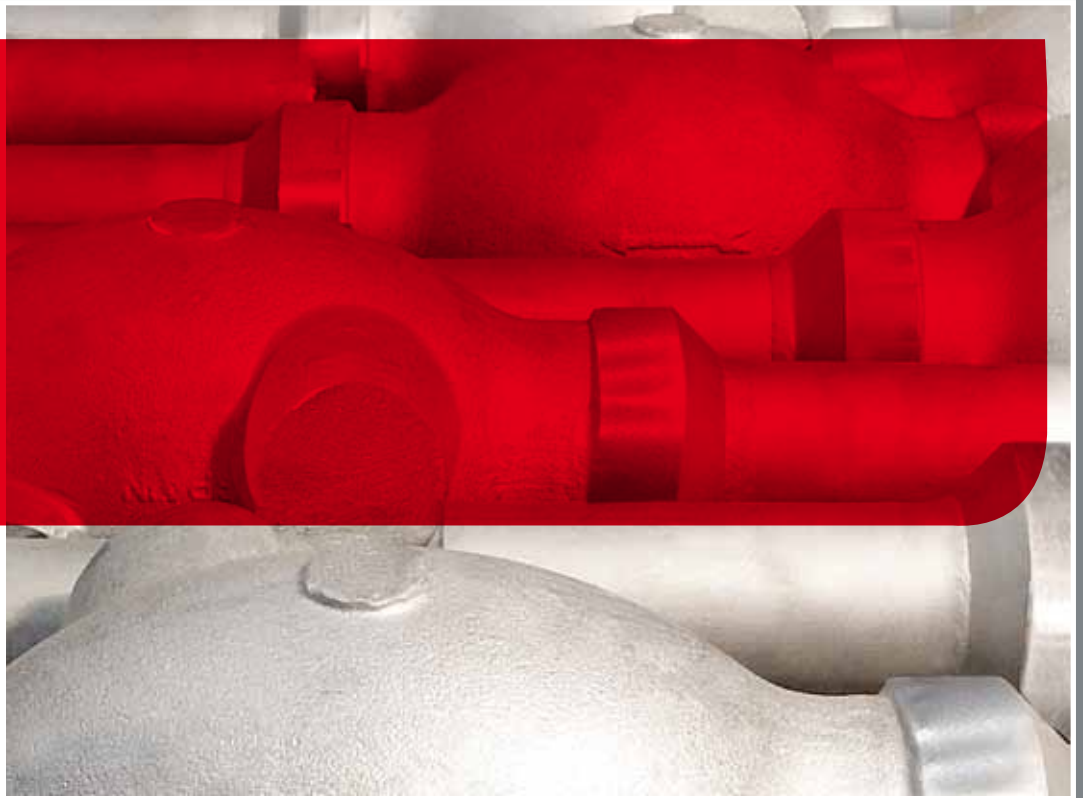

The standards and codes used are from the following institutions:

- API American Petroleum Institute.
- ASME American Society of Mechanical Engineers.
- ASTM American Society for Testing Materials.
- BSI British Standards Institution.
- MSS Manufacturers Standardization Society.

Globe valves are designed to comply with the following standards:

- BS1873
- API 600
- ASME B16.10
- ASME B16.25
- ASME B16.5
- ASME B16.47
- ASME B.16.34
- BS 6364
- ASME VIII

## GLOBE VALVES

- Standards:** API, BS, MSS, ASME, ASTM  
**Classes:** 150 lbs up to 2500 lbs  
**Sizes:** 1/2" up to 60"  
**Construction:** Bolted bonnet and Pressure seal. Extended bonnet (Gas column). Flanged and butt weld ends. Manual and motor-operated. Throttling Service Globe valves. Metal seats.  
**Temperature:** Down to -196°

## BOLTED BONNET

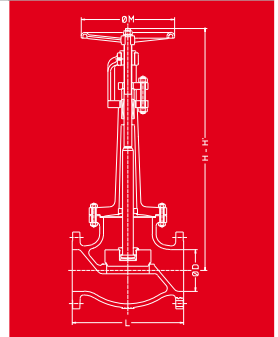

## EXAMPLE



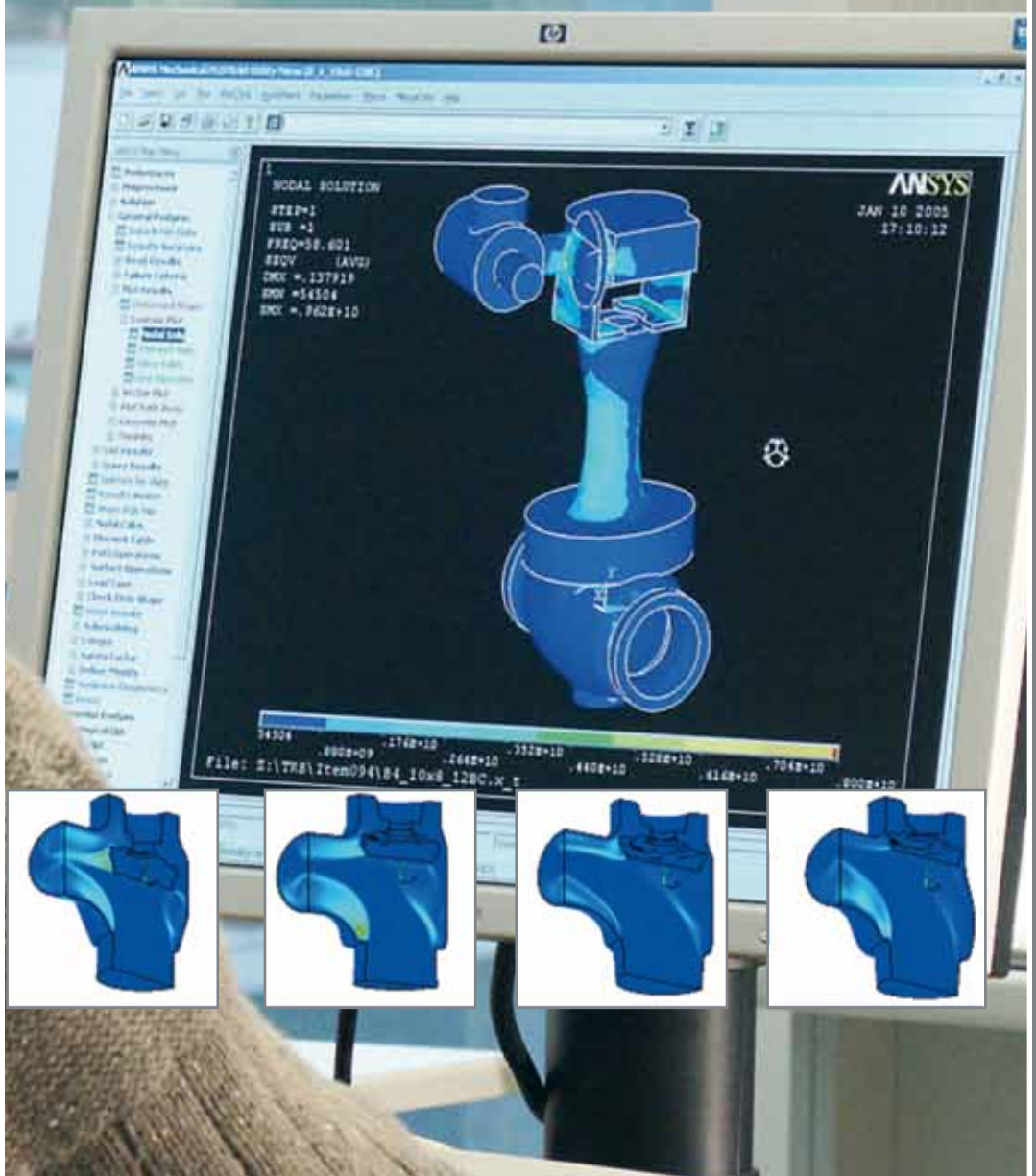
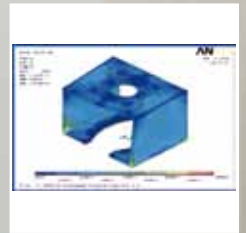
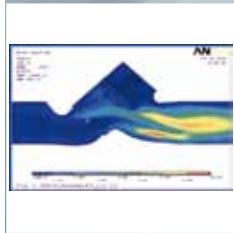

## 4.4 Cryogenic Check valves

Check valves are normally used in systems involving rapid and frequent flow reversals, pulsation or excessively turbulent flow should be avoided. These valves are suitable for low to moderate velocity LNG, water, oil, or other liquid service, and can only be used in horizontal pipe runs with the cover straight up.

Check valves are used to prevent flow reversal in piping systems. They are suitable for horizontal or vertical (flow up through valve only) piping runs. In order to guarantee the perfect operability, the standard design of AMPO Valves has a stop integrated on the cover.

Swing check valves have low pressure drop and are best suitable for moderate velocity applications. Either too low line velocity or too high velocity can damage valve internals and shorten valve life.

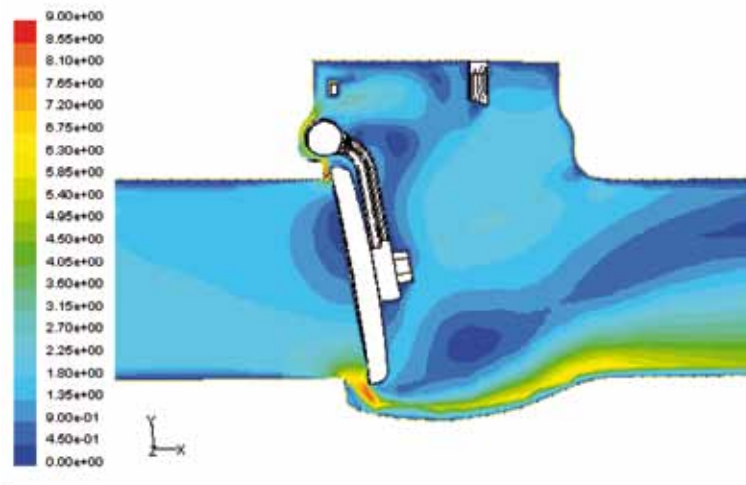

### Valve range and alternatives:

Cryogenic check valve range goes from 150# up to 2500# and from ½" up to 60" and can be bolted bonnet (BB) or pressure seal design (PS) depending on pressure ratings and project specifications.

At customer's request valves can be swing check type or piston check type.





### **Design and construction:**

As standard, swing check valves are designed with internal hinge but external hinge swing check valves are available with an optional outside gearbox, counterweight or damper. This feature can be used to make smoother or assist closing of the check valve disc depending on orientation. By the use of a counterweight for counterbalancing the disc, the valve can be opened at lower flow rates.

Apart from that, gear operated swing check valves are also manufactured. This kind of valve works as a common swing check valve but when a reverse flow is required by plant process, it can be operated and opened by mean of the handwheel. It is commonly used in LNG vessel discharge lines in order to make easier carrier cooling downs.

The standards and codes used are from the following institutions:

API American Petroleum Institute.

ASME American Society of Mechanical Engineers.

ASTM American Society for Testing Materials.

BSI British Standards Institution.

MSS Manufacturers Standardization Society.



Check valves are designed to comply with the following standards:

BS1868.

API 600.

ASME B16.10.

ASME B16.25.

ASME B16.5.

ASME B16.47.

ASME B.16.34.

ASME VIII.

### **Materials:**

Our own foundry allows us controlling the whole process of the high quality austenitic stainless steel valves for bodies, bonnets, etc. For spindle and other internal materials, apart from the common stainless steel laminated or forged material such as Gr304, 304L, 316, 316L, 347, 347L etc. high performance stainless steel material are used, such as S17400, NITRONIC 50<sup>®</sup>, MONEL K500<sup>®</sup>, etc.

Valve disc is normally hard faced by a stellite overlay and body seat is a integrated seat but any kind of combination can be manufactured.

Any kind of bolting material required by each specification and each process condition.

## CHECK VALVES

**Standards:**

API, BS, MSS, ASME, ASTM

**Classes:**

150 lbs up to 2500 lbs

**Sizes:**

1/2" up to 60"

**Construction:**

Bolted bonnet and Pressure seal. Extended bonnet (Gas column). Flanged and butt weld ends. Manual and motor-operated. Metal seats.

**Temperature:**

Down to -196°

## BOLTED BONNET

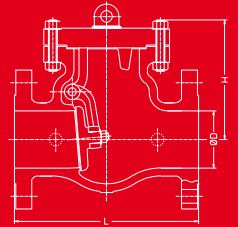

## EXAMPLE

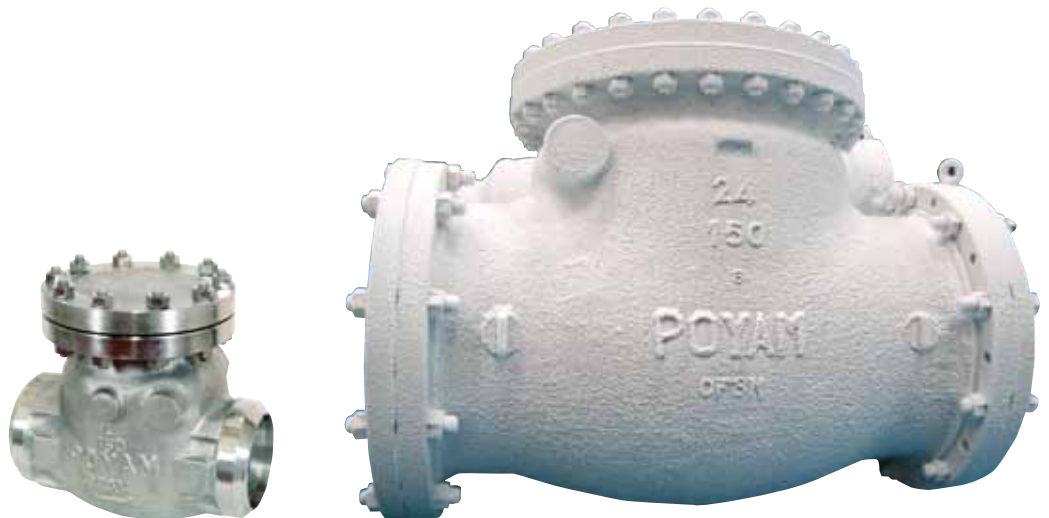



## 5. F.E.S

“AMPO engineers and technicians are willing to give integral assistance service to our customers”

- 1 Company Profile
- 2 General Overview of Cryogenic Service Valve
- 3 Why Choose AMPO Valves
- 4 Product Range
- 5 FES (Field Engineering Service)**
- 6 Sales Network



In 2005 AMPO officially launched the FES (Field Engineering Service) with the aim of:

1. Service improvement.
2. Client training and information transmission facilities.
3. Product live information: innovation
4. Client fidelity and satisfaction.

## 5.1 Construction Services

It is based on the training of construction personnel and process witnessing.

Works carried out during this process use to be the following ones:

- Inspection of the reception and storage systems of the equipment.
- Valve handling procedures for installation. Activity witnessing.
- Valve installation training and witnessing of the activity.
- Actuator installation.
- Actuator and gearbox regulation and adjustment.
- Gearbox and actuator rotation.
- Technical support during installation, tests and line blowing.
- Valve cleaning.





All these services are carried out following approved procedures and quality certificates are delivered to the customer at the end of the process. Procedures created in a close collaboration with EPC contractors and approved by end customers or valve users. Supported by an experience of more than 30 years giving service in the LNG market.

## **5.2 Maintenance Services**

With the aim of giving an integral assistance of maintenance, training and After Sales Engineering support, making smoother the valve performance, and assuring a correct operation and maintenance of the equipment.

Concentrated on:

- Predictive and preventive maintenance
- Corrective maintenance
- Operators and maintenance technicians training
- Spare part and valve supply

## 6. Worldwide Sales Network

“AMPO services are available worldwide through our Sales Network”

- 1 Company Profile
- 2 General Overview of Cryogenic Service Valve
- 3 Why Choose AMPO Valves
- 4 Product Range
- 5 FES (Field Engineering Service)
- 6 Sales Network**





Distributed by | Distribuido por :



**ANYTHING**  
**≈ FLOWS ≈**

[INFO@ANYTHINGFLOWS.COM](mailto:INFO@ANYTHINGFLOWS.COM)

[WWW.ANYTHINGFLOWS.COM](http://WWW.ANYTHINGFLOWS.COM)

**Flow Control , our passion ®**

**Life Flows on ™**



**SCAN ME**