

Explosion-proof solenoid valves

on/off and proportional controls - ATEX standard or Gosgortehnadzor Russian Standard

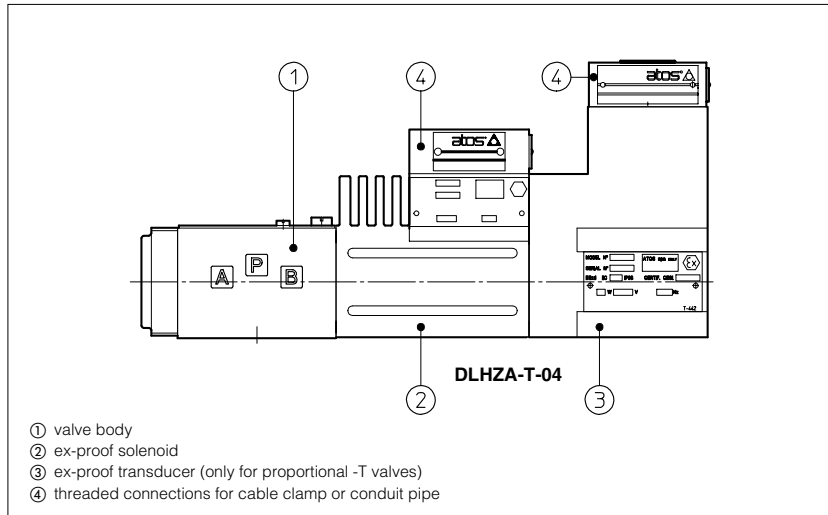

Explosion-proof on/off and proportional solenoids certified according to ATEX 94/9/CE, protection mode:

- Ex II 2 G EEx d IIC T6/T4/T3 (solenoids group II for surface plants with gas or vapours environment, category 2, zone 1 and 2);
- Ex I M2 EEx d I (solenoids group I for surface, tunnels or mining plants).
- Gosgortehnadzor Russian Certification, available for Group II solenoids

The solenoid case is designed to contain the possible explosion which could be caused by the presence of the gas mixture inside the housing, thus avoiding dangerous propagation in the external environment.

They are also designed to limit the external temperature according to the certified class to avoid the self ignition of the explosive mixture present in the environment.

These solenoids are applied to hydraulic valves for application in explosion-hazardous environments.

1 MODEL CODE OF ON/OFF DIRECTIONAL CONTROLS

DHA / * - 0 63 1/2 / PA - GK - * 24DC ** /*

DHA = spool type - direct
DLOH - DLOK = poppet type - leak free
DPHA = spool type - piloted

Only for DHA, DPHA
 Optional certifications (omit for Group II ATEX)
M = Group I, ATEX (mining)
RU = Group II, Gosgortehnadzor (Russian)

Valve size (ISO 4401) for all models excluded DLOH and DLOK

for DHA **0** = 06
 for DPHA **1** = 10
2 = 16
3 = 25

Valve configuration, see section 8

Spool type (only for DHA and DPHA), see section 8

Synthetic fluids:
WG = water-glycol
PE = phosphate ester

Design number

Supply voltage - see section 4

Certification type - only for DLOH and DLOK
AO = Group II, ATEX **AO/M** = Group I, ATEX (mining)
AO/RU = Group II, Gosgortehnadzor (Russian)

Solenoid threaded connection:
GK = GK-1/2" ISO/UNI-6125 (tapered)
NPT = 1/2" NPT ANSI B2.1 (tapered)
M = M20x1,5 UNI-4535 (6H/6g)

Options:

- WP** = prolonged manual override protected by metallic cap
- 7** = for ambient temperature up to 70°C
- PA** = with threaded cable clamp, see section 14
- A** = solenoid at side of port B

Only for DLOH:

- R** = with check valve on port P

2 MODEL CODE OF PROPORTIONAL DIRECTIONAL CONTROLS

DLHZA / * - T - 0 40 - L 7 3 / PA - GK /* ** /*

DHZA = size 06 without sleeve, see tab. F160, F165
DLHZA = size 06 with sleeve, see tab. F180
DKZA = size 10 without sleeve, see tab. F160
DLKZA = size 10 with sleeve, see tab. F180
DPZA = size 16 and 25, see tab. F170, F172

Optional certifications (omit for Group II ATEX)
M = Group I **RU** = Group II, Gosgortehnadzor (Russian)

A = for open loop application (not available for DL*ZA)
T = with integral transducer (not available for DPZA)

Valve size (ISO 4401):
0 = 06; **1** = 10; **2** = 16; **3** = 25

Valve configuration, see section 7

Regulation characteristic:

- L** = linear
- S** = progressive (not available for DL*ZA)
- D** = as S, but A and B flow path have ratio 1:2 (not available for DL*ZA)

Spool size, see technical tables: **3, 5** (for all models); **1, 7** (only for DL*ZA)

Fail safe configuration for DL*ZA **1** = A, B, P, T blocked **3** = P blocked; A, B, T tank connected

Synthetic fluids:
WG = water-glycol
PE = phosphate ester

Design number

Options:

- WP** = prolonged manual override protected by metallic cap (only for valves without transducer)
- 7** = for ambient temperature up to 70°C
- B** = solenoid at side of port A
- C** = current feedback signal 4÷20 mA (only for -T version)
- 24** = with 24 Vdc coils instead of standard 12 Vdc coils

Only for DPZA:

- G** = pressure reducing valve for piloting
- E** = external pilot (through port X)
- D** = internal drain

Solenoid threaded connection:
GK = GK-1/2" ISO/UNI-6125 (tapered)
NPT = 1/2" NPT ANSI B2.1 (tapered)
M = M20x1,5 UNI-4535 (6H/6g)

Option

- PA** = with threaded cable clamp, see section 14

3 MAIN DATA OF EXPLOSION PROOF SOLENOIDS

Solenoid type		PROPORTIONAL		ON/OFF	
Method of protection		EEx d			
Temperature class (only for Group II)		T4	T3 (option /7)	T6	T4 (option /7)
Surface temperature	Group II, ATEX/Gosgortehnadzor	≤ 135 °C	≤ 200 °C	≤ 85 °C	≤ 135 °C
	Group I, ATEX (mining)	≤ 150 °C			
Ambient temperature	Group II, ATEX/Gosgortehnadzor	-20 ÷ +40 °C	-20 ÷ +70 °C	-20 ÷ +45 °C	-20 ÷ +70 °C
	Group I, ATEX (mining)	-20 ÷ +60 °C			

4 MAIN DATA EXPLOSION PROOF SOLENOIDS

SOLENOID TYPE	PROPORTIONAL		ON-OFF
	without transducer	with transducer	
Group II, ATEX	OZA-A	OZA-T	OA
Solenoid code Group I, ATEX (mining)	OZAM-A	OZAM-T	OAM
Group II, Gosgortehnadzor	OZA/RU-A	OZA/RU-T	OA/RU
Supply voltage VDC	12 DC, 24 DC	12 DC	12, 24, 28, 48, 98, 110, 125, 198, 220
VAC 50/60 Hz	-		12, 24, 110/120, 220/240 (1)
Power consumption	35W		8W
Coil insulation	Class H		
Protection degree	IP 67 According to IEC 144 when correctly coupled with the relevant cable gland SP-PA*, see section 14		
Duty factor	100%		
Mechanical construction	Explosion proof safety case classified EEx-d, according to EN 50014 : 1997+A1...A2 EN 50048 : 2000		
Cable entrance and electrical wiring	Internal terminal board for cable connection for cable entrance, see section 14		

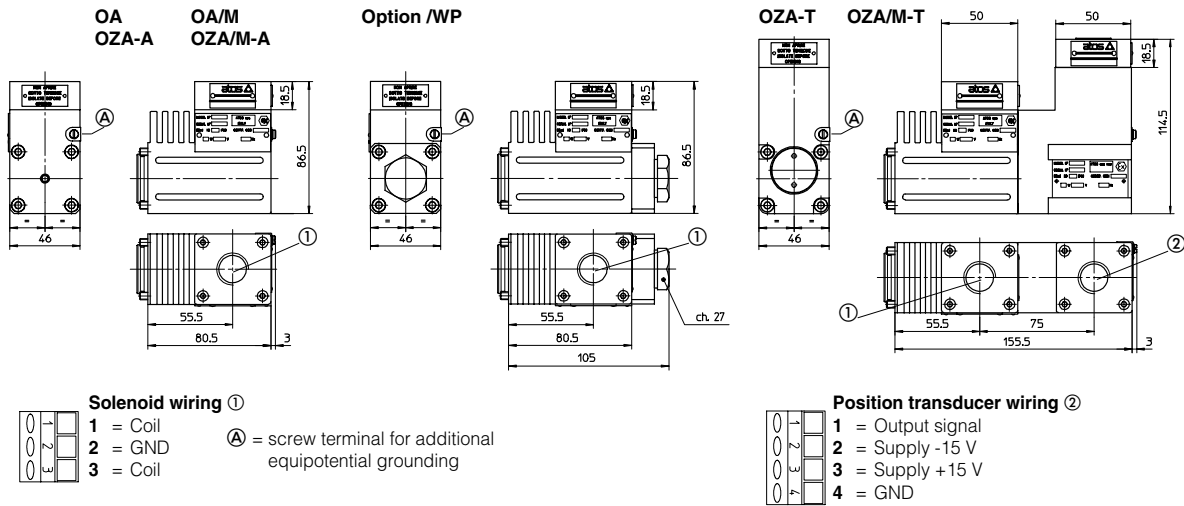

(1) For alternating current supply a rectifier bridge is provided built-in the solenoid

5 MODEL CODE OF MECHANICAL PRESSURE CONTROLS

AGAM - 20 / 2 0 / 210 / PA - GK - * 24 DC ** /*

<p>AGAM = pressure relief valve: subplate mounting, see tab. C066</p> <p>ARAM = pressure relief valve: threaded connections, see tab. C045</p> <p>Valve size for AGAM: 10 (ISO 6264), 20 (ISO 6264), 32 (ISO 6264)</p> <p>for ARAM: 20 = G 3/4", 32 = G 1 1/4"</p> <p>Number of the different setting pressure values (1, 2, 3)</p> <p>Valve configuration, see section 15</p> <p>0 = venting with de-energized solenoid 1 = venting with energized solenoid 2 = without venting</p> <p>Pressure range of first/second/third setting: 100 = 10 - 100 bar; 210 = 10 - 210 bar; 350 = 10 - 350 bar</p> <p>Options: 7 = for ambient temperature up to 70°C PA- = with threaded cable clamp, see section 14</p>	<p>Synthetic fluids: WG = water-glycol PE = phosphate ester</p> <p>Design number</p> <p>Supply voltage, see section 4</p> <p>Certification type AO = Group II, ATEX AO/M = Group I, ATEX (mining) AO/RU = Group II, Gosgortehnadzor (Russian)</p> <p>Solenoid threaded connection: GK = GK-1/2" ISO/UNI-6125 (tapered) NPT = 1/2" NPT ANSI B2.1 (tapered) M = M20x1,5 UNI-4535 (6H/6g)</p>
--	--

6 MODEL CODE OF COVERS FOR CARTRIDGE VALVES

LIDEW - 1 / PA - GK - * 24DC ** /*

<p>Cover type: LIDBH* = with solenoid valve and shuttle valve for pilot selection LIDEW* = with solenoid valve for pilot selection * = valve configuration, see tab. H030, section 2</p> <p>Cover size (ISO 7368) for LIDBH*: 1 = 16... 5 = 50 for LIDEW* 1 = 16... 8 = 80</p> <p>Options: 7 = for ambient temperature up to 70°C PA = with threaded cable clamp, see section 14 E = external attachments X (1/4" GAS) and underneath port X supplied plugged *** = restrictors different from standard ones, see tab. H030</p>	<p>Synthetic fluids: WG = water-glycol PE = phosphate ester</p> <p>Design number</p> <p>Supply voltage - see section 4</p> <p>Certification type AO = Group II, ATEX AO/M = Group I, ATEX (mining) AO/RU = Group II, Gosgortehnadzor (Russian)</p> <p>Solenoid threaded connection: GK = GK-1/2" ISO/UNI-6125 (tapered) NPT = 1/2" NPT ANSI B2.1 (tapered) M = M20x1,5 UNI-4535 (6H/6g)</p>
--	---

Note: for the code of the ISO cartridge to use with the above covers see tab. H003, section 2 and tab. H030, section 3.

7 HYDRAULIC CONFIGURATIONS OF DIRECTIONAL PROPORTIONAL CONTROLS

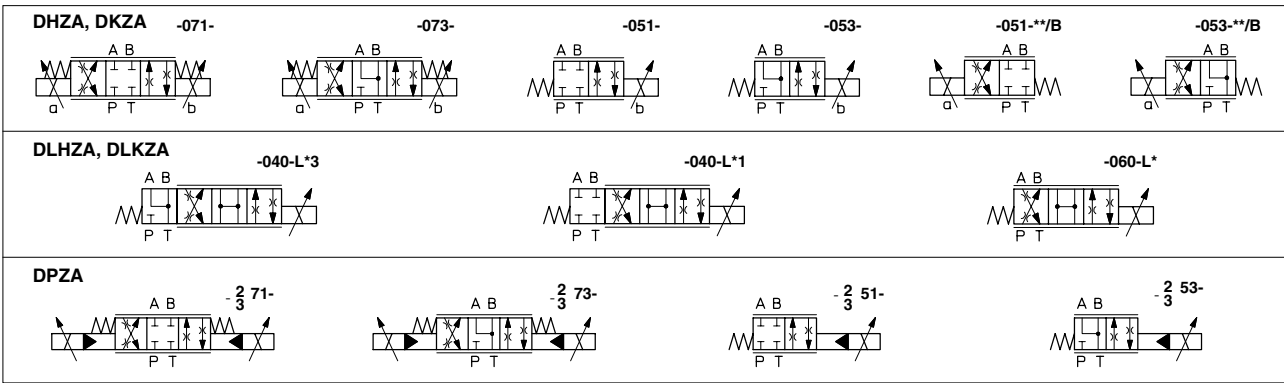

8 HYDRAULIC CONFIGURATIONS OF DIRECTIONAL ON/OFF CONTROLS

For the valve hydraulic configuration and the spool type, see:

DHA Table E010, sections 2 and 3; **DLOH* / DLOK*** Table E041, section 2;
DPHA Table E080, sections 2 and 3; **LIDBH* / LIDEW*** Table H030, section 2.

9 Q/Δp DIAGRAMS OF ON/OFF DIRECTIONAL CONTROLS (based on mineral oil ISO VG 46 at 50°C)

Flow direction Spool type	Flow direction				
	P→A	P→B	A→T	B→T	P→T
0	C	C	C	C	
0/2, 1, 1/2	A	A	A	A	
3	A	A	C	C	
4, 5	D	D	D	D	A
6	A	A	C	A	
7	A	A	A	C	
8	C	C	B	B	

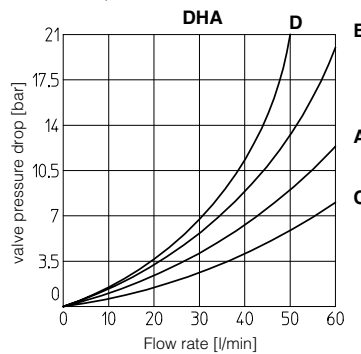

INTERNAL LEAKAGE of DLOH and DLOK less than 5 drops/min (0,36 cm³/min) at max pressure.

Flow direction Valve type	Flow direction	
	P → A (1) (P → B)	A → T (B → T)
DLOH-2A	B	-
DLOH-2C	C	-
DLOH-3A	D	C
DLOH-3C	C	A
DLOK-3A	G	F
DLOK-3C	F	E

(1) For two-way valves pressure drop refers to P→T

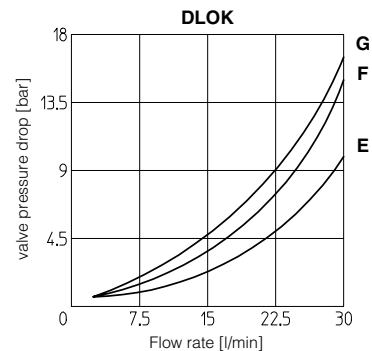
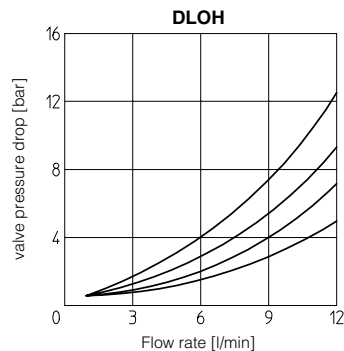

10 OPERATING LIMITS OF ON/OFF DIRECTIONAL CONTROLS (based on mineral oil ISO VG 46 at 50°C)

The diagram has been obtained with warm solenoids and power supply at lowest value ($V_{nom}=10\%$). For DHA valves the curves refer to application with symmetrical flow through the valve (i.e. P → A and B → T). In case of asymmetric flow the operating limits must be reduced.

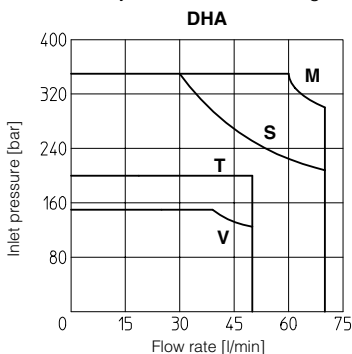

M = Spools 0, 1, 8; **T** = Spools 0/2, 1/2;
S = Spools 3, 6, 7; **V** = Spools 4, 5.

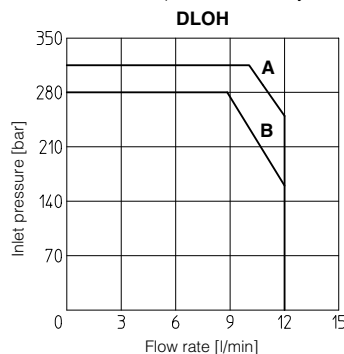

A = DLOH-3A;
B = DLOH-2A, DLOH-3C.

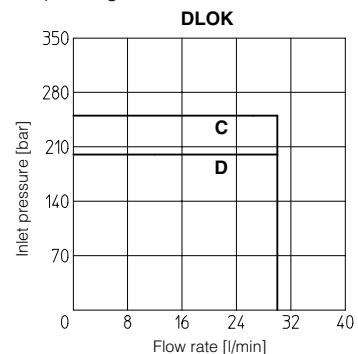

C = DLOK-3A;
D = DLOK-3C.

10.1 Max pressure in port T = 210 bar

11 OPERATING LIMITS OF PROPORTIONAL DIRECTIONAL CONTROLS

Valve type	DHZA-A, -T	DLHZA-T	DKZA-A, -T	DLKZA-T	DPZA-A-2	DPZA-A-3
Flow max	60	40	110	80	350	600
Δp max [bar]	50	70	40	60	40	40
Pressure max	P-A-B [bar]	350	350	315	350	350
	T [bar]	210	210	210	210	210

12 MODEL CODE OF PROPORTIONAL PRESSURE CONTROLS

RZMA / * - A - 010 / 250 / PA - GK / * ** /*

Pressure relief:
RZMA = see tab. F007
HZMA = see tab. F065
AGMZA = see tab. F035
LIMZA = see tab. F300

Pressure compensator:
LICZA = see tab. F300

Pressure reducing:
RZGA = see tab. F015
HZGA = see tab. F070
KZGA = see tab. F070
AGRCZA = see tab. F050
LIRZA = see tab. F300

Optional certifications (omit for Group II ATEX)
M = Group I, ATEX (mining)
RU = Group II, Gosgortehnadzor (Russian)
A = for open loop application

For RZMA e RZGA: **010** = size 06 (ISO 4401) For RZMA/HZMA: **030** = size 06 (ISO 4401)
 For RZGA: **033** = size 06 (ISO 4401) For HZGA: **031** = size 06 (ISO 4401)
 For AGMZA: **10** = size 10 (ISO 6264), **20** = size 20 (ISO 6264), **32** = size 32 (ISO 6264)
 For AGRCZA: **10** = size 10 (ISO 5781), **20** = size 20 (ISO 5781)
 For LIMZA, LICZA, LIRZA (ISO 7638): **16, 25, 32** (all models)
40 ; 50 (only LIMZA and LICZA)
63 (only LIMZA)

Synthetic fluids:
WG = water-glycol
PE = phosphate ester

Design number

Options:
7 = for ambient temperature up to 70° C
E = external pilot (only for AGMZA)
P = with integral mechanical pressure limiter (only for AGRCZA and LIRZA)
R = with check valve (only for AGRCZA)
24 = with 24 Vdc coils instead of standard 12 Vdc coils

Solenoid threaded connection:
GK = GK-1/2" ISO/UNI-6125 (tapered)
NPT = 1/2" NPT ANSI B2.1 (tapered)
M = M20x1,5 UNI-4535 (6H/6g)

Option
PA = with threaded cable clamp, see section 14

Max pressure:
32 = 32 bar (only for RZGA-A-010)
80 = 80 bar
100 = 100 bar (only for RZGA-A-010)
210 = 210 bar (only for RZGA-A-010)
180 = 180 bar
250 = 250 bar

13 MODEL CODE OF PROPORTIONAL FLOW CONTROLS

QVHZA / * - T - 06 / 12 / PA - GK / * ** /*

Pressure compensated, flow control valve:
QVHZA = see tab. F410
QVKZA = see tab. F410

Optional certifications (omit for Group II ATEX)
M = Group I, ATEX (mining)
RU = Group II, Gosgortehnadzor (Russian)
A = for open or closed loop application
T = with integral spool position transducer

Valve size (ISO 4401)
 QVHZA: **06** QVKZA: **10**

Max regulated flow:
 QVHZA QVKZA
3 = 3,5 l/min; **65** = 65 l/min
12 = 12 l/min; **90** = 90 l/min
18 = 18 l/min;
36 = 36 l/min;
45 = 45 l/min;

Synthetic fluids:
WG = water-glycol
PE = phosphate ester

Design number

Options:
WP = prolonged manual override protected by metallic cap (only for valves without transducer)
7 = for ambient temperature up to 70° C
C = current feedback signal 4-20 mA (only for -T versions)
24 = with 24 Vdc coils instead of standard 12 Vdc coils

Solenoid threaded connection:
GK = GK-1/2" ISO/UNI-6125 (tapered)
NPT = 1/2" NPT ANSI B2.1 (tapered)
M = M20x1,5 UNI-4535 (6H/6g)

Option
PA = with threaded cable clamp, see section 14

14 CABLE ENTRANCE

CABLE GLAND SP-PA19/*
CABLE GLAND SP-PAM19/* - for valves with mining certification (PG9 - IP67)

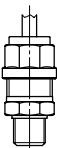

The cable glands are available on request certified ATEX according to EN 50.014 and EN50.018, see tab. K500.

Following codes have to be specified for spare cable glands:
SP-PA(M)19/GK = with threaded connection GK-1/2" ISO/UNI-6125 (tapered)
SP-PA(M)19/NPT = with threaded connection 1/2" NPT ANSI B2.1 (tapered)
SP-PA(M)19/M = with threaded connection M20x1,5 UNI-4535 (6H/6g).
 This cable gland must be blocked with loctite or similar or with a lock nut.

Note: special cable clamps PA112 (PG12) available on request only as spare parts.

The valves must be connected to the power supply using the terminal board inside the solenoid.

The cable must be suitable for the working temperature as specified in the "safety instructions" delivered with the first supply of the products.

Additional equipotential grounding can be also performed by the user on the external facility provided on the solenoid case. Minimum section of external ground wire = 4 mm². Minimum section of internal ground wire = the same of supply wire. In order to reach the terminal board inside the solenoid, the top plate of the solenoid must be removed.

Solenoids are provided with threaded connection for cable entrance: GK-1/2" GAS (ISO/UNI 6125) or M20x1,5 (UNI-4535) or 1/2"NPT (ANSI B2.1)

15 EXTERNAL PROFILE OF EX-PROOF VALVES

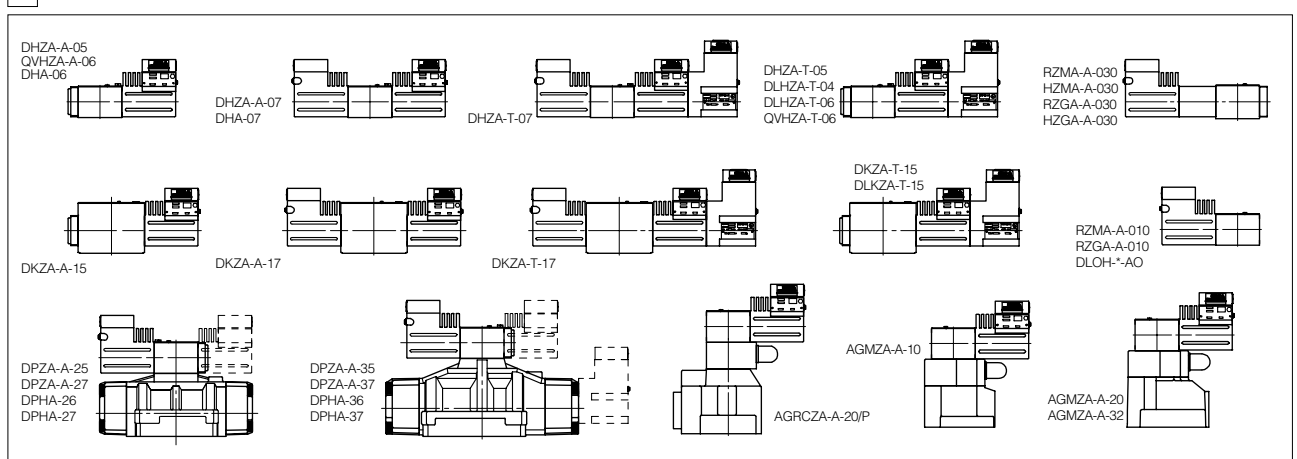

Diagram showing external profiles of various valves:

- DHZA-A-05, QVHZA-A-06, DHA-06
- DHZA-A-07, DHA-07
- DHZA-T-07
- DHZA-T-05, DLHZA-T-04, DLHZA-T-06, QVHZA-T-06
- RZMA-A-030, HZMA-A-030, RZGA-A-030, HZGA-A-030
- DKZA-A-15
- DKZA-A-17
- DKZA-T-17
- DKZA-T-15, DLKZA-T-15
- RZMA-A-010, RZGA-A-010, DLOH-A-010
- DPZA-A-25, DPZA-A-27, DPHA-26, DPHA-27
- DPZA-A-35, DPZA-A-37, DPHA-36, DPHA-37
- AGMZA-A-10
- AGRCZA-A-20/P
- AGMZA-A-20, AGMZA-A-32

Distributed by | Distribuido por :



ANYTHING
≈ FLOWS ≈

INFO@ANYTHINGFLOWS.COM

WWW.ANYTHINGFLOWS.COM

Flow Control , our passion ®

Life Flows on ™



SCAN ME